

# The *new* EZ2000(V), EZ3200(V) & EZ3500(V) Electronic Scale Indicators



## Technical Manual

By

***Digi-Star*** 

***FEATURES: These models have enhanced features such as:***

- Scrolling Help Messages for easy operation
- Large 1.7" display (1" for EZ2000) for greater readability
- Front panel calibration without simulator or weights
- Expanded self diagnostic test capability
- Scrolling Help Messages for easy operation
- SELECT and FUNCTION keys to simplify appearance and allow for future expansion
- A HOLD feature to hold the weight stable while moving the scale system
- Fiber-optic back lighting for extremely long life
- New powerful microprocessor and expanded memory

**OPERATING SPECIFICATIONS:**

Accuracy.....0.1% with System Accuracy depending on load cells used  
Temperature Range.....-20 to 140 degrees F  
Power Requirements..... 10.2 - 16 VDC

**DIGI-STAR**  
790 WEST ROCKWELL AVENUE  
FORT ATKINSON, WISCONSIN 53538  
PHONE (920) 563-1400  
TECHNICAL SERVICE (920) 563-9700

# EZII Series Technical Manual

## Table of Contents

<b>1.</b>	<b>Short Form Calibration .....</b>	<b>4</b>
<b>2.</b>	<b>Long Form Setup Values.....</b>	<b>8</b>
<b>3.</b>	<b>Self Test.....</b>	<b>38</b>
<b>3.1</b>	<b>Initiating the Self Test.....</b>	<b>38</b>
<b>3.2</b>	<b>Test Sequence.....</b>	<b>38</b>
<b>4.</b>	<b>Weighing Errors .....</b>	<b>40</b>
<b>5.</b>	<b>RS-232 Specifications .....</b>	<b>41</b>
<b>5.1</b>	<b>Signal Levels.....</b>	<b>41</b>
<b>5.2</b>	<b>Communication Parameters .....</b>	<b>41</b>
<b>5.3</b>	<b>Port Wire Connections .....</b>	<b>41</b>
<b>5.4</b>	<b>Computer Command Set.....</b>	<b>42</b>
<b>5.5</b>	<b>Numeric Entry Commands .....</b>	<b>42</b>
<b>5.6</b>	<b>Scoreboard Data Format.....</b>	<b>42</b>
<b>5.7</b>	<b>Print Data Format - Two Line .....</b>	<b>43</b>
<b>5.8</b>	<b>Print Data Format - One Line .....</b>	<b>44</b>
<b>5.9</b>	<b>Print Samples .....</b>	<b>45</b>
<b>5.10</b>	<b>Computer Interface Print Samples .....</b>	<b>46</b>
<b>5.11</b>	<b>CSV Print Format.....</b>	<b>46</b>
<b>6.</b>	<b>DDL Set Up Requirements .....</b>	<b>50</b>
	<b>Appendix A Short Form Calibration .....</b>	<b>51</b>
	<b>Determining the SETUP number .....</b>	<b>52</b>
	<b>Adjusting the Indicator to Match Another Scale .....</b>	<b>53</b>
	<b>Appendix B Weigh Method Descriptions .....</b>	<b>57</b>
	<b>Adjustment Options for Weigh Methods #1 and #2.....</b>	<b>58</b>
	<b>Appendix C Long Form Setup and Calibration .....</b>	<b>61</b>
	<b>Appendix D Self Test Error Messages.....</b>	<b>63</b>
	<b>Error Descriptions .....</b>	<b>63</b>
	<b>Key Locations and Switch Numbers .....</b>	<b>67</b>
	<b>Keypad Failure Error Codes.....</b>	<b>67</b>
	<b>Initiating Key Test.....</b>	<b>68</b>
	<b>Terminating the Test .....</b>	<b>68</b>

<b>Appendix E - Operating the Mix Counter Feature .....</b>	<b>69</b>
<b>Purpose.....</b>	<b>69</b>
<b>Setup and Drive Ratio Determination.....</b>	<b>69</b>
<b>Installing the Proximity Sensor .....</b>	<b>71</b>
<b>7. Appendix F Serial Cable Drawings.....</b>	<b>72</b>

EZ2000/EZ2000V Operator Manual _____	See F3531
EZ3200 Operator Manual _____	See F3570
Remote RD2000 and RD2000V Displays _____	See F3416
EZ3500 Operator Manual _____	See D3599

**Always keep this manual by your scale indicator.**

All rights reserved. Reproduction of any part of this manual in any form whatsoever without Digi-Star's express written permission is forbidden. The contents of this manual are subject to change without notice. All efforts have been made to assure the accuracy of the contents of this manual. However, should any errors be detected, Digi-Star would greatly appreciate being informed of them. The above notwithstanding, Digi-Star can assume no responsibility for any errors in this manual or their consequence.

# EZII Series Technical Manual

## 1. Short Form Calibration

### Warning!

This indicator was calibrated at the factory to weigh accurately with your system.

Additional calibration is not necessary under normal conditions.

The *Short Form Setup & Calibration* procedure allows you to change the “SETUP” and “CAL” numbers of the indicator. You may want to perform this procedure if:

- The indicator is being connected to different load cells, or
- you want to adjust the calibration to match another scale system.

Before continuing, first write down the current SETUP and CAL numbers of your EZ indicator. These numbers are displayed during the Self Test. To run the self test:

With the indicator already ON, press the  key to start the Self Test. Press the  key to "pause" the Self Test while numbers are displayed. Press the  key again to "resume".

SETUP # \_\_\_\_\_ CAL # \_\_\_\_\_

Keep this information for future reference.

**Note:** Do not attempt to calibrate the scale if the indicator is not reading stable weights. The calibration procedure **will not fix** instability, inconsistencies, or flashing "RANGE" messages.

The Short Form has only two values: SETUP and CAL.

**Note:** The Short Form Values are NOT displayed in Long Form Setup. See Appendix A: for additional Short Form information.

**To Enter Short Form Setup**

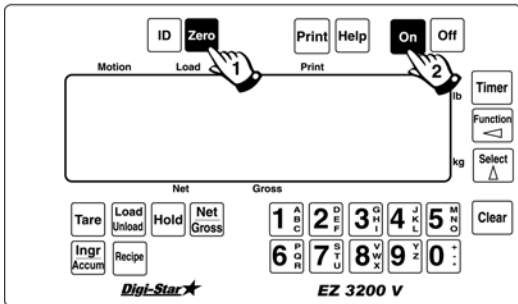

Press and hold the **Zero** key and then press the **On** key.

**Setup Number (SETUP)**

1 4 6 0 4 0  
W G D C C C

The digits in this number represent four different items. From left to right: WGDCCC.

- W = Weigh Method
- G = Gain
- D = Display Count Index (0-9)
- CCC = Capacity/1000

The word SETUP is displayed briefly. Next, a number is displayed. The digit on the indicator farthest to the right flashes. Use the **Tare** or **Function** key to change which digit is active (flashing). Use the **Net Gross** or **Select** key to change the value of the digit.

**W=Weigh Method**

This value selects the weigh method or signal averaging scheme to be used by the scale system and the Display Unit.

Weigh Method Settings	Characteristic
1-LB	General
2-LB	Slow
3-LB	Fast
4-LB	Lock-On
5-KG	General
6-KG	Slow
7-KG	Fast
8-KG	Lock-On

*See Appendix B for additional information.*

**G=Gain**

**Gain.** This value selects the amplification to be used on the loadcell signal. This is application-specific and should only be altered by trained technicians. This value is NOT accessible in the Long Form setup.

**D=Display Count Index (0-9)**

This is an index into the following table:

Index	Display Count
0	< .2
1	0.2
2	0.5
3	1
4	2
5	5
6	10
7	20
8	50
9	100

**CCC=Capacity/1000**

These can be selected in the Long Form setup. This number represents capacity divided by one thousand.

**Press the ON key to advance to the calibration number.**

**Calibration Number { CAL }:**

This value represents the weight this scale would display with a loadcell input of .4mV/V.

An example of a **Calibration Number** could be "**032890**".

Press the  key to enter the calibration number.

*Note:* The system automatically returns to the normal weighing mode after Calibration Number is set.

## 2. Long Form Setup Values

The Long Form Setup/Calibration is split into four (4) menus. See Appendix C for a tabled explanation of each. Menu selections for the entire EZII Series are listed here. Optional features in the table below appear in *italics*. The Setup/Calibration values that are available depend on the options installed. For example, the setup values Time Format (TIME F) , Time (TIME), Date Format (DATE F), and Date (DATE) will not be displayed if the “Clock Option” is not installed.

Menu 1	Menu 2	Menu 3	Menu 4	CALIB
LANGAG DRATE MOTION ZTRACK W MTHD LOCKON TR HLD SCALID LKNHLD	TIME F* TIME* DATE F* DATE* TAREAP 1L PRT SCOREM APRINT COM IN PRTFMT MEDIA C1 DLY C2 DLY EST WT†	COUNT ARANGE LB-KG CAP WM1-A1 WM1-A2 WM1-A3 WM2-A1 WM2-A2 WM2-A3	P-MTHD/P-ALM RM INP AL OUT BUZZER PRETAR TMRCTR DRATIO E MTHD TOLER DELAY INGNM ACCUM USERID MSTOR RESIZE RECTOT INGSIZ SCOOP% AERROR	TCALB CAL

\* Available only if clock option is installed.

† Only option in menu on an EZ2000.



**To Enter Long Form Setup**

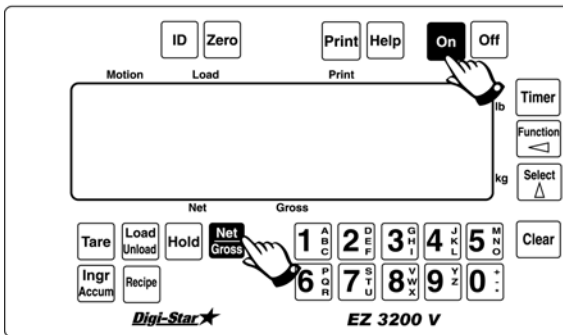

Press and hold the **Net Gross** key and then press the **On** key.

The following message is displayed:

“PRESS SELECT – MENU 1 – MENU 2 – MENU 3 – CALIBRATION – EXIT – THEN PRESS ON KEY”

Press the **Select** key to select which menu to enter. Press the **On** key to select and proceed to the next menu item.

**To Exit Long Form Setup**

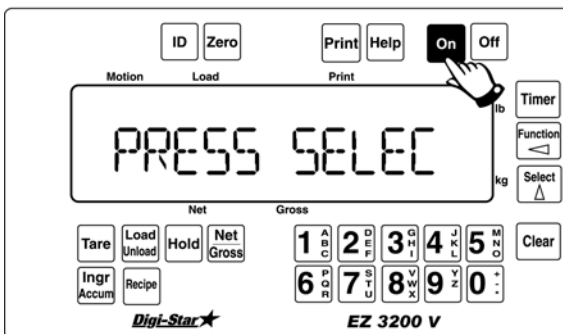

To EXIT the Setup/Calibration, press the **On** key after the message: “PRESS SELECT – MENU 1 – MENU 2 – MENU 3 – CALIBRATION – EXIT – THEN PRESS ON KEY” is displayed.

## Help Messages

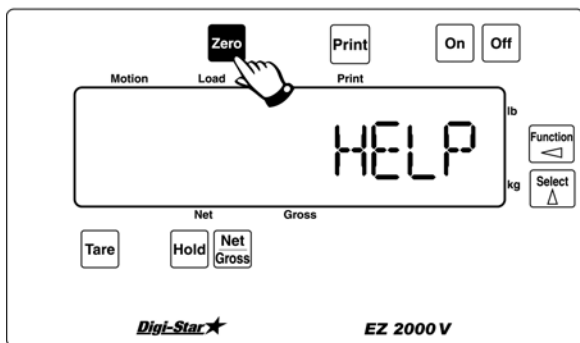

At anytime during the Long Form setup, press the **Zero** key (or the HELP key on 2000V and EZ3200) for additional information.

## Menu 1 Options

### LANGAG (Language Setup)

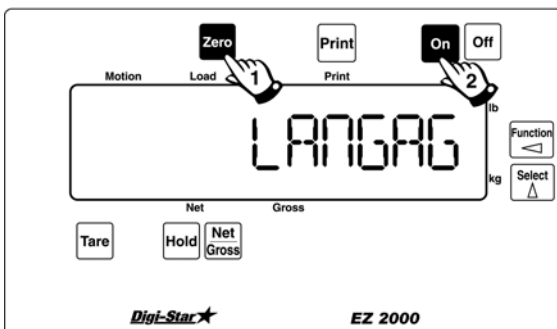

Select the language that will be used to display **Help Messages**. Press the **Help** key (on an EZ2000 use the [ZERO] key to display Help messages) to scroll through the options. Press the **On** key to enter selection and proceed to the next menu item.

Select one of the following:

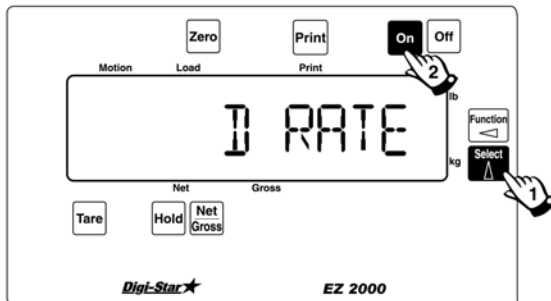

- English *ENGLISH*
- Dutch *NEDERL*
- French *FRANCS*
- German *DEUTSH*
- Italian *ITALAN*
- Portuguese *PORT*
- Spanish *ESPANL*
- Danish *DANSK*

## D RATE (Display Rate Setup)



Select the number of times per second to update the display. This also applies to remote units if installed.

Select 1, 2, 3, or 4.

Press the  key to scroll through options, press the  key to enter selection and proceed to the next menu item.

**Note:** When selecting the Weigh method (General, Slow, or Fast) or when setting the Weigh Method Adjustment Options (see Menu #3 of the Long Form Setup), a change in Display Rate affects how the weight appears on the scale. A selection of '1' update per second helps to stabilize the weight. A selection of '4' updates per second provides more response to weight changes but may cause the weight to appear “jumpy.” The Display Rate is set to '2' at the factory.

## MOTION (Motion Setup)

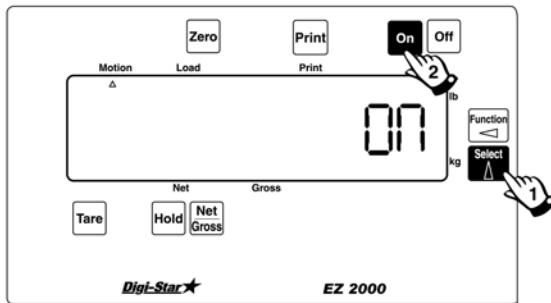

Select On or Off. If set to On, an annunciator flashes under the word Motion on the display to indicate unstable weight.

The MOTION parameter limits operation if the scale is unstable. It does not correct for the instability. It is up to the operator to correct the unstable environment.

The following items are disabled until the weight is stable:

- Printer output
- Zero/Balance function
- Tare function
- Ingredient Auto-advance

**Note:** Motion is temporarily turned on during all system weight calibrations to insure a stable measurement. It is turned off after calibration if Off was selected in Motion setup.

## ZTRACK (Zero Track Setup)

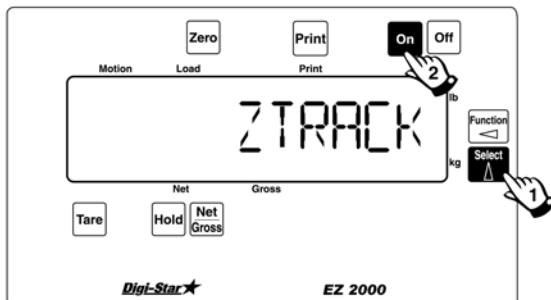

Select On or Off. If set to On, the scale will adjust for small weight variances. This allows the scale to compensate for such things as mud or snow accumulation on a platform scale. The maximum instantaneous weight that zero tracking can remove is approximately 0.05% of the scales Capacity Limit value or

$$\text{Max. Weight} = .0005 * \text{Capacity Limit}$$

**Note:** Zero Tracking is temporarily turned Off during all system weight calibrations to insure a proper “ZERO/BALANCE” is obtained. It is “turned on” after calibration if “ON” was selected in setup.

## W MTHD (Weigh Method Setup)

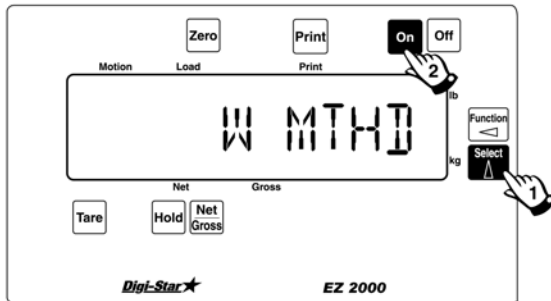



Select the weigh method:

- 1 – General
- 2 – Slow
- 3 – Fast
- 4 – Lock-On



**Note:** Setting the Weigh Method in the “Long Form” **DOES NOT** affect the Display Unit LB/KG.

**Note:** Weigh method adjustments are available to allow the operator to adjust the filtering characteristics of Weigh Methods #1 and #2. These adjustments change how the scale processes the weight signal received from the loadcells. See Weigh Method Adjustment Options (WM1-A1) in Menu #3 of the Long Form Setup.

Press the  key to scroll through options. Press the  key to enter selection and proceed to the next menu item.

*See Appendix B for additional information*

## LOCKON

Press the  key to scroll through selections 1 thru 9. Press the  key to store setting and proceed to the next menu item.



Select 1-9.

A low value, such as 1 or 2, allows the system to be more sensitive to animal movement. A high value, such as 8 or 9, will allow the scale to lock on faster. Use the lowest setting that still allows the system to lock on consistently.

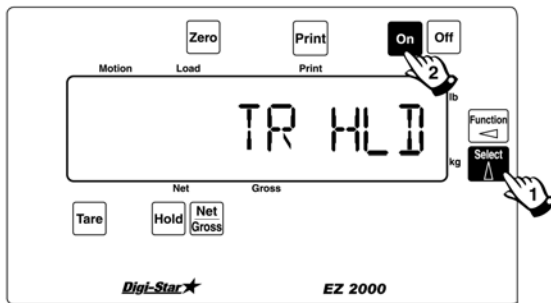
---

**TR HLD (TR Inventory Hold)**

Displays GROSS weight if TR key (on the handheld transmitter) is held for three (3) seconds.

Press the  key to scroll through options. Press the  key to enter selection and proceed to the next menu item.

---

**SCALID (Scale ID Setup)**

This feature allows the operator to identify the scale with a (truck or mixer number).

After entering the SCALID menu, the scale's default name "NEW EZ" will be displayed on the screen.

Press "CLEAR" several times to clear out the existing number and enter the desired scale identification number or letter on the numeric keypad. Press the  key to store the ID number and advance to the next menu item.

**LKNHLD (Lock & Hold)**

Press the  key to toggle the "Lock & Hold" feature to "ON".

Place an animal onto the platform. Once "locked", the weight will be displayed until another animal (that exceeds 2.5% of scale capacity) steps on the platform.

The indicator will return to normal weighing after 5 minutes if no other animal steps on the weighing platform. The Recheck key can also be used to return the indicator to the weighing mode.

Press the  key to enter the selection and advance to the next menu item.



---

**Menu 2 Options**

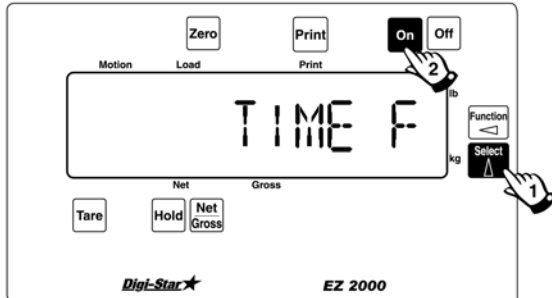

**TIME F (Time Format)**

Select AM/PM or 24 HR.





Press the  key to scroll through options, press the  key to enter selection and proceed to the next menu item.

**TIME**

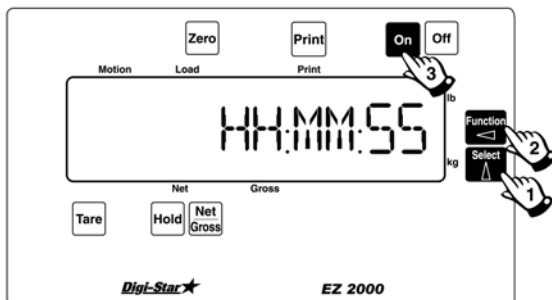
Enter the desired time. Time format is HH:MM:SS. Press and hold the  key to change the time. The  key only increases digit, keep scrolling until the desired number is displayed.



Press the  key to move from SS to MM to HH.

Press the  key when finished entering the correct time.

If AM/PM format has been selected for time format, then AM/PM is displayed.

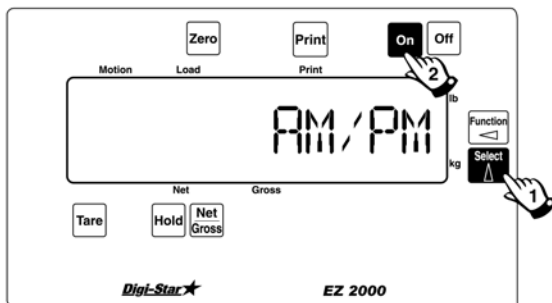



**Note:** This is only displayed if the Time has been changed.

Press the  key to select AM or PM as needed.

Press the  key to enter selection and proceed to the next menu item.

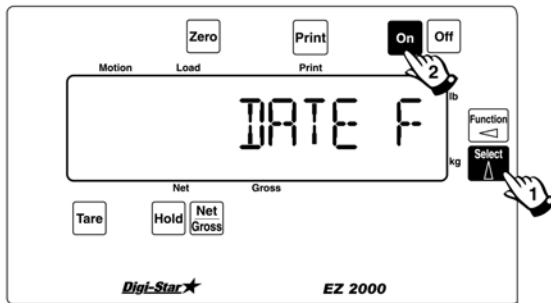
## DATE F (Date Format)



Select the date format. Press the  key to view the formats available. Select one of the following:

- 1 = MM/DD
- 2 = MM/DD/YY
- 3 = MM/DD/YYYY
- 4 = DD/MM
- 5 = DD/MM/YY
- 6 = DD/MM/YYYY
- 7 = DD/MO/YY
- 8 = DD/MO/YYYY

MM = 2 digit month (ex. January=01)

DD = 2 digit date (ex. 23)

YY = 2 digit year (ex. Year 2000=00)

YYYY = 4 digit year (ex. 2000)

MO= 2 character month (ex. January=JA)



Press the  key to enter selection and advance to the next menu item.



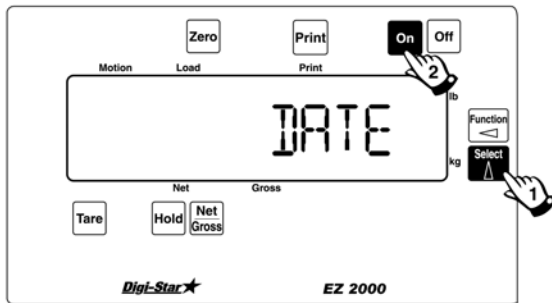

**DATE**



Enter the date in the format selected in the DATE F option.

Press the  key or the  key to increment the value of the flashing digit (month, day, or year).

Holding the  key or the [NET/GROSS] key down increments the digit at a faster rate (similar to setting a digital alarm clock).

Use the  key or the  key to select which value is changed (month, day, or year).

Press the  key to enter selection and proceed to the next menu item.

**TAREAP (Tare Auto Print Setup)**

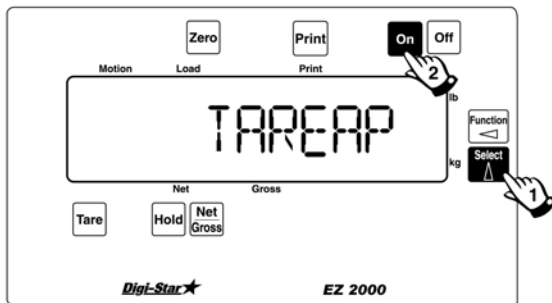



Press the  key to choose On or Off.

If On, when pressed, the  key will auto print the displayed weight.

Press the  key to enter selection and proceed to the next menu item.

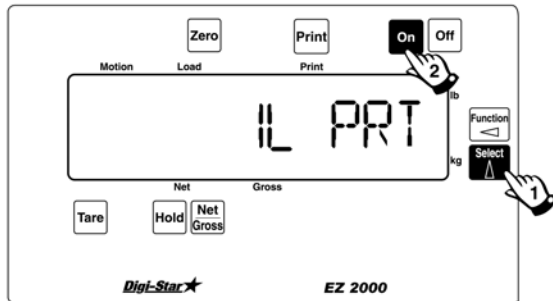
### 1L PRT (One Line Print)



Press the **Select**  key to choose On or Off. If On, scale data will be printed on one line. If Off, scale data will be printed on multiple lines.

Press the **On**  key to enter selection and proceed to the next menu item.

### SCOREM (Scoreboard Mode Setup)

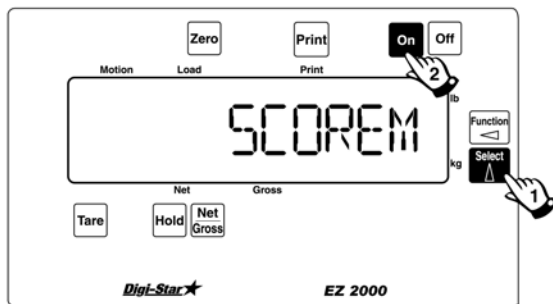



Press the **Select**  key to choose the scoreboard output mode. This determines how quickly the remote display is updated. Choose one of the following:

- 1 Remote display updates once per second
- 2 Remote display updates twice per second
- 3 Remote display updates three times per second
- 4 Remote display updates on every conversion
- 5 Remote display updates at the display rate
- 6 Remote display updates when the display weight changes

Press the **On**  key to enter selection and proceed to the next menu item.

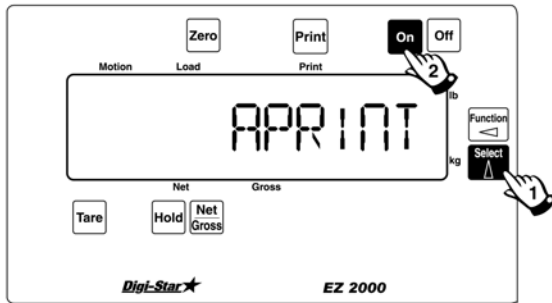
**APRINT (Auto Print Setup)**



Press the  key to choose On or Off. If On, pressing the following keys will auto print weight values:

TARE, TR, ID, LOAD/UNLOAD, NET/GROSS, and PRINT

Auto Print prints all transactions. This feature also works with wireless transmitters.

Press the  key to enter the selection and proceed to the next menu item.

**COM IN (Computer Input Line)**

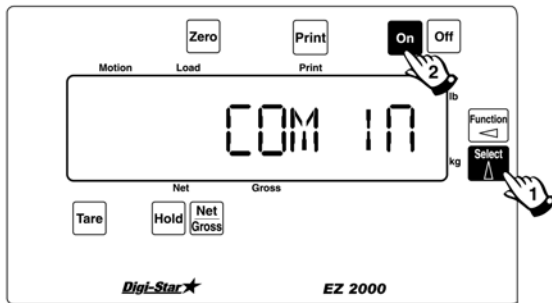

Indicates what is connected to the serial/printer port. Both settings will work when connected to a printer. Press

the  key to choose one of the following:



- DWNLD** (connect to data downloader)
- EZ CMD** (connect to computer)

Press the  key to enter the selection and proceed to the next menu item.

**PRTFMT (Print Format)**

This feature allows user to select from the following list of print formats:

AUTO	Standard Print Formats
WTONLY	Weight Only
DOWNLD	Original Downloader Output
DT+TM	CSV Weight, Date & Time
ID+TM	CSV Weight, ID, Time
IDWTTM	CSV ID, Weight, Time
ANIMAL	CSV See Section 5.10
3200-A	CSV See Section 5.10
3200-B	CSV See Section 5.10
32-TMR	See EZ3500 Operator Manual

Press the  key to choose from the above menu and press the  key to enter the selection and proceed to the next menu item. See section 5 for detailed output format.

---

**MEDIA (Media Type)**

This menu allows the user to select either Datakey (DATAKY) or DDL as the data storage device to be used with the indicator.

Press the  key to choose either DATAKY or DDL.

Press the  key to enter the selection and proceed to the next menu item.

---

**C1 DLY (Print Delay)  
C2 DLY**

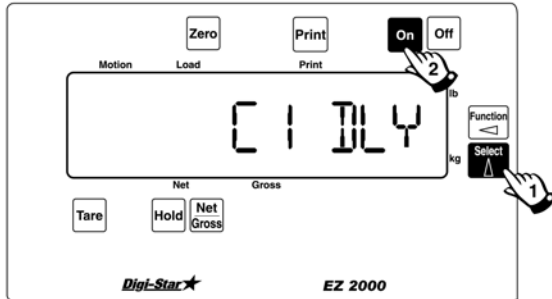

Press the **Select** key to choose the number of seconds the printer will delay before advancing to the next print line. Select one of the following:

OFF	No delay
.10	1/10 of a second
.25	1/4 of a second
.50	1/2 a second
.75	3/4 of a second
1	1 second
2	2 seconds
3	3 seconds
4	4 seconds
5	5 seconds

If printer has a buffer, use OFF. If using the downloader, select .10 or .25 seconds. The downloader needs a minimum of .10 seconds after each line.

Press the **On** key to enter the selection and proceed to the next menu item.

**EST WT (Estimated Gross Weight)**

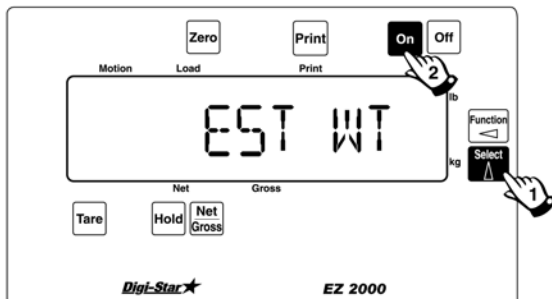

Press the **Net Gross** key or the **Select** key to increment the value of the flashing digit.

Use the **Tare** key to add digits to the number.

Use the EST WT to enter a new GROSS weight. This feature allows the operator to adjust the gross weight on the scale.

**Press ON to continue.**

**Menu 3 Options**

**COUNT (Display Count Setup)**

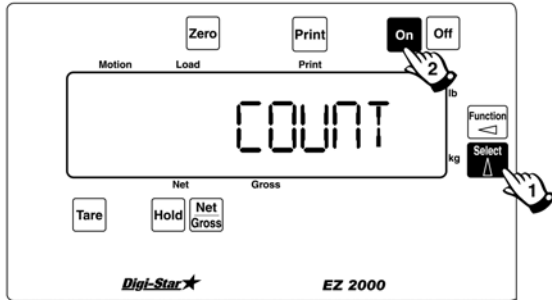

Press the  key to indicate the display count.

Indicator displays count in increments of 0.01, 0.02, 0.05, 0.1, 0.2, 0.5, 1, 2, 5, 10, 20, 50, and 100.

**Note:** If you set the count too small for the calibration, the readings will be unstable and the indicator will not be accurate.

Press the  key to enter selection and proceed to the next menu item.

**ARRANGE (Auto Range Setup)**

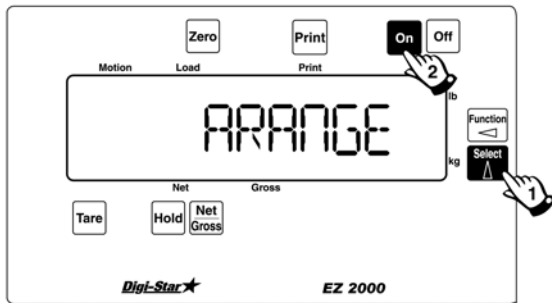

Press the  key to choose On or Off. If On, increases display count size for weights over 300 and again at 600 lbs/kgs.

For example, 0 to 300 lbs. (1 lb. increment), 30 to 60 lbs. (2 lb. increment), 60↑ (5 lb. increment)

Press the  key to enter selection and proceed to the next menu item.

**LB-KG (Weight Unit Setup)**

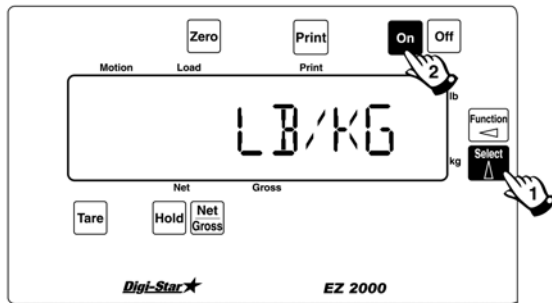

Press the **Select** key to choose to display weight values in lbs (pounds) or kg (kilograms).

Press the **On** key to enter selection and proceed to the next menu item.

**CAP (Scale Capacity Setup)**

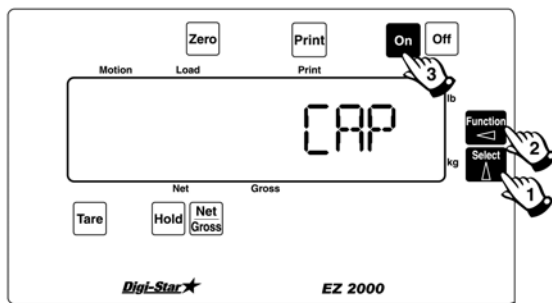

Use to set the maximum weight for the scale. CAP should never exceed sum of load cell capacities.

Press the **Net Gross** key or the **Select** key to increment the value of the flashing digit.

Holding the **Net Gross** key, or **Select** key, down increments the digit at a faster rate (similar to setting a digital alarm clock).

Use the **Tare** key or the **Function** key to select which value is changed.

Press the **On** key to enter selection and proceed to the next menu item.

---

**WM1-A1 (Weigh Method Adjustments  
for Weigh Method #1 – General)**

Press the  key to choose a value from 2 – 100 (factory setting = 10).

This setting is the main “filter” setting for the weigh method. A small filter number such as 2 or 4, causes the scale to respond quickly to weight changes, but may cause the display to appear “jumpy.” A large filter number, such as 32 or 64, causes the scale to be more stable, but the scale is “slow” to respond to weight changes.

Press the  key to enter selection and proceed to the next menu item.

*See Appendix B for more information.*

---

**WM1-A2 (Weigh Method Adjustments  
for Weigh Method #1 – General)**

Press the  key to choose a value from 0 – 100 (factory setting = 4).

When this adjustment is set to a value other than 0, it activates a “Quick Response” feature. This allows the scale to quickly respond to large weight changes.

Press the  key to enter selection and proceed to the next menu item.

*See Appendix B for more information.*



**WM1-A3 (Weigh Method Adjustments  
for Weigh Method #1 – General)**

Press the  key to set the “Quick Response Weight” for Weigh Method #1 (General).

If weight added to the scale is greater than the amount set here, the “Quick Response Average Number” setting of WM1-A2 is used as the filter number. The default is 10% of the scale’s capacity. For example, if this value is set to 3000, the weight must change more than 3000 lbs before Weigh Method #1 will use the “Quick Response Average Number” set in WM1-A2. Once close to the actual weight, Weigh Method #1 uses the filter number set in WM1-A1.

Press the  key to enter selection and proceed to the next menu item.

*See Appendix B for more information.*

---

**WM2-A1 (Weigh Method Adjustments  
for Weigh Method #1 – Slow)**

Press the  key to choose a value from 2 – 100 (factory setting = 30).

This adjustment is the “Maximum Average Number” setting for Weigh Method #2 (Slow). This number determines how many of the previous weight samples to average. A small average number such as 2 or 4 causes the scale to respond quickly to weight but may cause the display to appear “jumpy.” A large filter number, such as 32 or 64, causes the scale to be more stable, but the scale is “slow” to respond to weight changes.

Press the  key to enter selection and proceed to the next menu item.

*See Appendix B for more information.*

---

**WM2-A2 (Weigh Method Adjustment  
for Weigh Method #2 – Slow)**

Press the  key to choose a value from 0 – 100 (factory setting = 10).

This adjustment is the “Quick Response Average Number” setting for Weigh Method #2 (Slow). If adjustment 2 is set to a value other than 0, it activates the “Quick Response” feature. This allows the scale to quickly respond to large weight changes.

Press the  key to enter selection and proceed to the next menu item.

*See Appendix B for more information.*

---

**WM2-A3 (Weigh Method Adjustment for Weigh Method #2 – Slow)**

Adjustment 3 sets the “Quick Response Weight” for Weigh Method #2 (Slow).

If weight added to the scale is greater than this amount, the “Quick Response Average Number” setting of WM2-A2 is used as the filter number. The default is 10% of the scale’s capacity. For example, if this value is set to 3000, the weight must change more than 3000 lbs before Weigh Method #2 will use the “Quick Response Average Number” set in WM2-A2. Once close to the actual weight, Weigh Method #2 increases the “Quick Response Average Number” on each conversion until the number of averages equals the Maximum Average Number set in WM2-A1.

Press the  key to enter selection and proceed to the next menu item.

*See Appendix B for more information.*

Press  to continue.



**Menu 4 Options****P-MTHD (Pre-Alarm Setup)**

Press the  key to choose either WEIGHT or PERCENT.

Press the  key to enter the selection and proceed to the next menu item.

**P-ALM (Pre-Alarm Setup)**

This value represents a pre-alarm weight value (lb, kg or percent). This acts as a setting point for activating the pre-alarm.

The value can be entered using the  and the  key or by using the numeric keypad.

Setting a pre-alarm weight to zero(0) disables this feature.

Press the  key to enter the selection and proceed to the next menu item.

**RM INP (Remote Input Setup)**

When set to PRESET, the Remote Input on the power cord (and the input from the TR option) will re-enter the last preset value entered. When set to TARE, the Remote Input performs the TARE function and “zeroes” the display. If using “Rotation Counter” (optional on 3200 & 3500), set to “MIXCTR”. This disables “PRESET” and “TARE”. Feature.

On the EZ3200, the options are the same. However, if a recipe is loaded, the TARE function causes the Remote Input to advance ingredients. If no recipes are loaded, the Remote Input performs a TARE.

Press the  key to select MIXCTR, PRESET or TARE.

Press the  key to enter the selection and proceed to the next menu item.

---

**AL OUT (Alarm Output)**

When set to TR, the Alarm Output allows the alarm capabilities of the preset alarm to be controlled by the TR keys. The Front Panel Alarm light and the relay output is ON (+12V) when a TR command has been accepted by the scale. PRESET causes the alarm capabilities to be controlled by the preset alarm.

Press the  key to choose either TR or PRESET.

Press the  key to enter the selection and proceed to the next menu item.

---

**BUZZER (Buzzer On/Off)**

Press the  key to set the buzzer to On or Off. If On, a buzzer will sound if alarm conditions occur.

Press the  key to enter selection and proceed to the next menu item.

---

**PRETAR (Preload Tare)**

The PRETAR feature allows the tare weight of a container to be entered using the numeric keypad.

Press the  key to set the PRETAR “ON” to enable the preload tare feature.

Press the  key to enter selection and proceed to the next menu item.

---

**RELAY (Alarm Relay On/Off)**

This feature allows the operator to enable or disable the Alarm Output Relay. This output is the orange wire of the power cord identified as the +12VDC ALARM. This output is active whenever the Pre-Alarm or Preset weight has been loaded.

Press the  key to set the RELAY “ON” to enable the alarm relay.

Press the  key to enter selection and proceed to the next menu item.

---

**TMRCTR (Mix Timer Counter)**

The Mix Timer feature displays mixer auger revolutions based on input pulses from a revolution-sensing device and an adjustable drive ratio that indicates how many pulses equal one (1) revolution.



Press the  key to select either “REV” or “TIME”.

Press the  key to enter selection and proceed to the next menu item.

---

**DRATIO (Mix Timer Drive Ratio)**

The Drive Ratio is a number that tells the indicator how many pulses equal 1 mixer revolution. The drive ratio can be any number between 0.01 and 999.99.

The value can be entered using the  key and the  key or by using the numeric keypad.

Setting a pre-alarm weight to zero(0) disables this feature.

Press the  key to enter the selection and proceed to the next menu item.

---

**E MTHD (Ingredient Entry Method)**

Select the entry method to use when programming recipes. Select one of the following:

- 1 – Amount per animal
- 2 – Percent per load
- 3 – Amount per load

Press the  key to select the entry method.

Press the  key to enter selection and proceed to the next menu item.

---

**TOLER (Ingredient Tolerance)**

Select the amount by percentage that an ingredient can be under or over-loaded and still automatically advance. Set this value to Off to always advance after the ingredient amount has been reached.

Tolerance settings in percentages

OFF, 0.5, 1, 2, 3, 4, 5, 7, or 10

Press the  key to select the desired tolerance.

Press the  key to enter selection and proceed to the next menu item.



---

**DELAY (Ingredient Advance Delay)**

If “DELAY” is not set to “MANUAL” the indicator is in the “Auto-Advance” mode. “DELAY” controls the number of seconds to wait before auto-advancing to the next ingredient of a recipe. Delay can be set to MANUAL, 1, 2, 3, 5, 7, 10, 20, 30, or 60.

Press the  key to select the desired setting.

Press the  key to enter the selection and proceed to the next menu item.

When set to “MANUAL”, use the  key or the  key is to advance to the next ingredient.

---

**INGNM (Ingredient Name)**

Attach ingredient names to items in the ingredient table.

Press the  key to toggle the “Ingredient Name” feature “ON”.

Press the  key to enter the selection and proceed to the next menu item.



---

**ACCUM (Accumulation)**

Enables recipe accumulation.

---

**USERID (Force User ID)**

Set to ON or OFF. If ON, operator MUST enter User ID before using the scale.

Press the  key to toggle the “User ID” feature “ON”.

Press the  key to enter the selection and proceed to the next menu item.

---

**MSTORE (Media Storage)**

Set to “QSTART” (Quick Start), “MANUAL” or “AUTO”

Press the  key to select the desired setting.

Press the  key to enter the selection and proceed to the next menu item.

Use the “QSTART” setting for Datakey only.

Manual mode can be used for Datakey or DDL.

Auto mode is not recommended for use with the Datakey.

---

**RESIZE (Re-Size Recipe)**

“RESIZE” allws the user to change the recipe size by changing the amount to feed or the number of animals for each pen.

Press the  key to toggle the “RESIZE” feature “ON”.

Press the  key to enter the selection and proceed to the next menu item.

---

**RECTOT (Recipe Total)**

“RECTOT” if turned on, provides 4 methods of correcting the batch size based on previous batch size errors.

Press the  key to toggle the “RECTOT” feature “ON”.

Press the  key to enter the selection and proceed to the next menu item.

---

**INGSIZ (Ingredient Re-Size)**

“INGSIZ” if turned on, changes the batch size based on the weight of the first ingredient loaded.

Press the  key to toggle the “INGSIZ” feature “ON”.

Press the  key to enter the selection and proceed to the next menu item.

---

**SCOOP% (Display Scoop Percentage)**

“SCOOP%” if turned on the displays tells the operator how much to fill the loader bucket or how big of a “silage cut” to make. The scoop weight is entered in the ingredient table.

Press the  key to toggle the “SCOOP%” feature “ON”.

Press the  key to enter the selection and proceed to the next menu item.

**AERROR (Auto Error)**

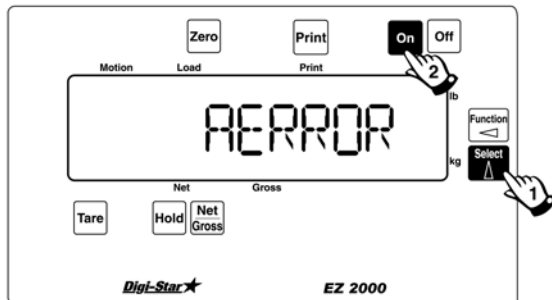

Press the  key to set Auto Error to “ON” or “OFF”. If “ON”, error messages are displayed to notify operator of system errors.

*See Appendix D for a list of errors and descriptions of each error.*

**Press ON to continue.**

## Calibration Menu Options

### T CALB (Temperature Calibration)

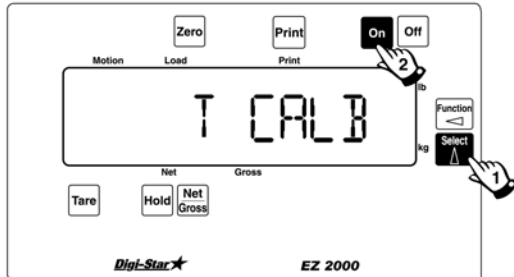

Press the  key to set temperature compensation to On or Off.

If On, the scale compensates for changes in temperature that affect the circuitry in the indicator.



The scale does not process load cell signals during TCALB. The *CAL* annunciator is on momentarily during TCALB.

For example, if set to On, the indicator recalibrates often when first turned on. Recalibration decreases as the indicator warms up.

---

Scale calibration can be performed at this time.



**CAL (Dead Weight Calibration)**

1. After the system has been properly zeroed, place a known weight value (ex., 5000 lb. test weight) on the scale platform.
2. Press the  key. If calibration weight is at least 5% of the scale capacity, the message “CAL” will be displayed.
3. If the scale capacity is *not* at least 5%, the system will not accept the calibration value and display the message “ADD WT”. Add more weight to the scale until the 5% capacity weight has been exceeded.
4. After the 5% capacity weight has been reached, the indicator displays the message “CAL”. The weight value estimated to be on the scale at that time is displayed. The weight on the scale is estimated based on the previous calibration value.
5. Correct the weight value by pressing the  key to increment the flashing digit and the  key to select the digit to change.

The scale will not accept the weight entered if motion is detected (weight is not stable) and will display the error message “MOTION.”

6. When the display reads the correct weight, press the  key to automatically determine and store the full scale calibration value.

The message “GOOD” is displayed for a successful calibration.

Press  and  to return to the normal weighing mode after Calibration

### 3. Self Test

#### 3.1 Initiating the Self Test

After turning the scale on, wait for normal operation to begin then press the ON key. The Self Test tests all settings and performs an internal system check to ensure that the indicator is working and set properly.

#### 3.2 Test Sequence

---

##### Start of Test Sequence:

The word **TEST** flashes, then the message “**SETUP**” is displayed.

If the Scoreboard option is installed, the message “**TEST**” may be displayed during the Self Test on the scoreboard data line, depending on the SCOREM selection.

---

##### Display Setup Value:

The system displays the Short Form **Setup** Value first, then the Short Form **Calibration** value.

---

##### Display Calibration Number:

---

##### Display Temperature Calibration Count:

---

##### Display LCD Segments:

The system then cycles through all display segments to help the operator identify any faulty areas.

---

##### Display Program ID:

Displays the current version (revision number) of the software.

---

##### System Test:

The indicator displays the message “**RUNNING SELF TEST – PLEASE WAIT**” while performing internal system testing.

Self Test cannot be paused or terminated during this ten (10) second test.

---



**Self Test System Errors:**

If system errors are discovered during internal diagnostics, the operator will see an error message. For example, "ERROR 1 – PRESS NET/GROSS TO CONTINUE" followed by "\*\*\* INDICATOR NEEDS SERVICE \*\*\* PRESS NET/GROSS TO CONTINUE".

Sending a command using the Computer Interface causes the system to terminate the error messages and attempt normal system operation.



---

**Pausing the Test:**

Press the  key during the self test to pause the sequence. Press the  key again to restart the test.

---

**Terminating the Test:**

The self test terminates and continues normal operation  errors are detected or if keys other than  are pressed.

---

## 4. Weighing Errors

### Capacity Limit:

The display shows the message "OVRCAP" if the weight on the scale system exceeds the capacity limit. The capacity value is entered in SETUP to warn of overloading the scale system.

### Over Range:

The display shows the message "+RANGE" if the weight on the scale system exceeds the maximum weight measurable by the scale system. The over range value is always the system's maximum A/D counts multiplied by the scaling factor. The actual weight at which over range occurs depends on the calibration, zero, and display count size.

### Under Range:

The display shows the message "-RANGE" if the weight on the scale system is less than the minimum weight measurable by the scale system. The under range value is always the system's minimum A/D counts multiplied by the scaling factor. The actual weight at which under-range occurs will depend on the calibration, zero, and display count size.

**Note:** The EZII Series supports -RANGE that is approximately equal to +RANGE in absolute value.



**5. RS-232 Specifications**

**5.1 Signal Levels**

The Printer, Computer, and Scoreboard are capable of communicating using the EIA Registered Standard #232 (RS-232). The signal levels move between +8 and -8 Volts.

The Scoreboard also has another communication port that drives 20 milli-Amp devices.

**5.2 Communication Parameters**

Data is transmitted and received in the asynchronous ASCII format. This communication format is compatible with most printers, computers, and terminals. The Alternate Port Configuration is used when the Scoreboard Mode (SCOREM) is set to 4.

<u>Standard Port Configuration</u>	<u>Alternate Port Configuration</u>
1200 BAUD	9600 BAUD
1 Start Bit	1 Start Bit
7 Data Bits	7 Data Bits
1 EVEN Parity Bit	1 EVEN Parity Bit
1 Stop Bit	1 Stop Bit

“Handshake lines” are *not* used and XON/XOFF is *not* supported.

*These parameters are not adjustable in the scale. Equipment interfacing to the scale must match this configuration.*

**5.3 Port Wire Connections**

All serial communications use the J904 connector on the bottom panel of the scale. See Appendix E for additional information.

Device	Function	J904 Pin
To Printer	RS-232 out	Pin 2
	Printer Ground	Pin 6
From Computer	RS-232 In	Pin 3
	Computer Ground	Pin 5
To Scoreboard	RS-232 Out	Pin 4
	Scoreboard Ground	Pin 7

**Also on the J904 connector:**

Device	Function	J904 Pin
Scoreboard	20mA Current Loop(+)	Pin 1
	Scoreboard 20mA Current Loop(-)	Pin 8

## 5.4 Computer Command Set

The Computer Interface controls the scale's operation by a remote RS-232 computer. Most commands acknowledge completion of the command by outputting the appropriate data stream.

**Single Letter** commands are always in capital letters (UPPER CASE).

The following **Single Letter** commands are supported:

B	Balance indicator, enter GROSS mode.
C	Perform CM (Clear Memory)
G	Enter GROSS mode.
H	Prints the average weight of the values in the memory feature.
M	Perform M+ (Memory Plus)
N	Enter NET mode, TARE if necessary.
P	Print weight data.
R	Perform RM (Recall Memory)
T	Perform TARE and enter NET mode.

See Format Example

### Format Example - B

B - (ASCII Dec. 66) Zero/Balance command.

## 5.5 Numeric Entry Commands

*Numeric Entry* commands do *not* include capital letters. The letters entered in a numeric entry are lower case. They are sent with the numbers first (one to six numbers with values 0-9) followed by a **lower case** letter.

The following *Numeric Entry* commands are supported:

t	Preload a TARE value 0-999999.
---	--------------------------------

### Format Example – 60t

60 - Tare Weight

t-(ASCII Dec. 116) Preload Tare

## 5.6 Scoreboard Data Format

Data is sent from the scale to the scoreboard at a frequency determined by the Scoreboard Mode (SCOREM) setting. The weight data is sent in the following format:

```
<stx>ABBBCD<cr>
```

Where:

<stx> is the ASCII control code "START OF TEXT"(dec. 2).

<cr> is the ASCII control code "Carriage Return" (dec. 13).

A is one of the following:

- minus sign
  - SPACE
  - number
- B is a number or a SPACE.
- C is a number, SPACE, or a minus sign (-) indicating a TR command is active.
- D is a number or a minus sign (-) indicating that motion is active.

### 5.7 Print Data Format - Two Line

Data is sent from the scale to the printer whenever the:

- PRINT key is pressed.
- TR option is used.
- Tare auto-print TAREAP is ON.
- Auto-print APRINT is On.

Date and Time make up the first line and will only be present if the *Clock Option* is installed.

The data is sent in the following format (see the DATE F menu option in *Setup/Calibration* for other format options):

```
_____dymoyr__hh:mmA<cr><lf>
xxxxxxID__yxxxxxLB_GR<cr><lf>
```

Where:

<cr> is the ASCII control code "Carriage Return" (dec. 13).

<lf> is the ASCII control code "Line Feed" (dec. 10).

\_ represents a SPACE.

dymoyr is date (Day, Month, & Year format selected in Long Form "DATE F" setting).

hh:mm is Time (hours:minutes).

A is either A (AM), or P (PM) or a space – format is selected in Long Form "TIME F" setting.

x is a number (0-9), or a SPACE.

ID labels the Identification Number (I.D.#).

y is a number (0-9), SPACE, or a minus sign (-).

LB is either Pounds (LB), or Kilograms (KG).

GR labels the weight amount

GR - Gross  
 NE - Net  
 TA - Tare  
 M+ - Memory Plus  
 RM - Recall Memory  
 CM - Clear Memory  
 TP - Tare Point Entered

### 5.8 Print Data Format - One Line

Data is sent from the scale to the printer whenever the:

- PRINT key is pressed.
- TR option is used.
- Tare auto-print TAREAP is On.
- Auto-print – APRINT is On.

Date and Time make up the last part of the line and are only present if the *Clock Option* is installed.

The data is sent in the following format. See the DATE F menu option in *Setup/Calibration* for other format options. This format must be used with the downloader:

```
xxxxxxID_yxxxxxLB_GR_dymoyr_hh:mmA<cr><lf>
```

Where:

- <cr> is the ASCII control code "Carriage Return" (dec. 13).
- <lf> is the ASCII control code "Line Feed" (dec. 10).
- \_ represents a SPACE.
- dymoyr is date (Day, Month,& Year format selected in Long Form "DATE F" setting).
- hh:mm is Time (hours:minutes).
- A is either A(AM), or P(PM) or a space, format is selected in Long Form "TIME F" setting.
- x is a number(0-9) or a SPACE.
- ID labels the Identification Number (I.D.#).
- y is a number(0-9), SPACE, or a minus sign '-'.
- LB is either Pounds(LB), or Kilograms(KG).

GR labels the weight amount.

- GR - Gross
- NE - Net
- TA - Tare
- M+ - Memory Plus
- RM - Recall Memory
- CM - Clear Memory
- TP - Tare Point Entered

**5.9 Print Samples**

Shown below are additional print samples from the "EZ" family of scale indicators.

General Information:

- The weight and Identification Numbers can have leading spaces.
- The weight information can have a decimal point (100910 or 10091.0).
- The ASCII Carriage Return (Dec. 13) is represented as <.
- The ASCII Line Feed (Dec. 10) is represented as ^.

In order to identify the line location of the characters, a simple column position identifier is shown directly above the PRINT DATA:

```

1         2         3         4
1234567890123456789012345678901234567890
    
```

**For example - Print Data with the Identification Number Option:**

```

1         2         3         4
1234567890123456789012345678901234567890
123456ID 109700LB GR<^<^                <- PRINT DATA LINE 1
    
```

Shows that the:

- ID# (123456ID) starts at column 1 of line 1.
- WEIGHT (109700LB -> 109,700 pounds) starts at column 10 of line 1.
- GR Scale was in the GROSS mode, starts at column 19 of line 1.
- <^ Carriage Return (Dec. 13) & Line Feed (Dec. 10).
- <^ Carriage Return (Dec. 13) & Line Feed (Dec. 10).

**The same Print Data with Identification Number & Clock Options:**

```

1         2         3         4
1234567890123456789012345678901234567890
      21JA91 11:22A<^                <- PRINT DATA LINE 1
123456ID 109700LB GR<^<^                <- PRINT DATA LINE 2
    
```

Shows that the:

- DATE (21JA91 -> January 21, 1991) starts at column 7 of line 1.
- TIME (11:22A -> 11 hours, 22 minutes AM) starts at column 14 of line 1.
- <^ Carriage Return (Dec. 13) & Line Feed (Dec. 10).
- ID# (123456ID) starts at column 1 of line 2.
- WEIGHT (109700LB -> 109,700 pounds) starts at column 10 of line 2.
- GR Scale was in the GROSS mode, starts at column 19 of line 2.
- <^ Carriage Return (Dec. 13) & Line Feed (Dec. 10).
- <^ Carriage Return (Dec. 13) & Line Feed (Dec. 10).

**The same Print Data with Identification Number & Clock Options, BUT with the One Line Print (1L PRT) feature enabled:**

```

      1           2           3           4
1234567890123456789012345678901234567890
123456ID 109700LB GR 21JA91 11:22A<^      <- PRINT DATA LINE 1
    
```

Shows that the:

- ID# (123456ID) starts at column 1 of line 1.
- WEIGHT (109700LB -> 109,700 pounds) starts at column 10 of line 1.
- GR Scale was in the GROSS mode, starts at column 19 of line 1.
- DATE (21JA91 -> January 21, 1991) starts at column 22 of line 1.
- TIME (11:22A -> 11 hours, 22 minutes AM) starts at column 29 of line 1.
- <^ Carriage Return (Dec. 13) & Line Feed (Dec. 10).

**5.10 Computer Interface Print Samples**

Most commands acknowledge completion of the command by outputting the appropriate data stream.

*Single Letter* commands are always in capital letters (UPPER CASE).

*Numeric Entry* commands are *not* in capital letters. (They are in lower case). They are sent with the numbers first (one to six numbers with values 0-9) followed by a lower case letter.

***Single Line print feature is shown below - this can be selected in the "Long Form Setup".***

<u>Command Sent</u>	<u>Printer Output Data Stream</u>			
	1	2	3	4
	1234567890123456789012345678901234567890			
N	123456ID	260LB NE	10JL93	7:09P
B	123456ID	0LB ZR	10JL93	7:09P
T	123456ID	600LB TA	10JL93	7:09P
G	123456ID	600LB GR	10JL93	7:10P
M	123456ID	605LB M+	10JL93	7:10P
M	123456ID	605LB M+	10JL93	7:10P
R	123456ID	1210LB RM	10JL93	7:10P
C	123456ID	0LB CM	10JL93	7:10P

**5.11 CSV Print Format**

Comma Separated Values (\*.CSV) make it easier to input scale data into PC Spreadsheet and Data Base programs. This feature allows several print formats to be selected, including CSV. These print formats are outputted anytime the [Print] key is pressed during normal weighing or normal batching. The formats are:

- | <u>Name</u> | <u>Description</u>  |
|-------------|---|
| " AUTO "    | - Standard print formats.   |
| "WTONLY"    | - Simple weight value. Must be selected for AGCO (Hesston, Hay & Forage). |

- Includes weight, display unit, '\$' if unit is "locked-on", weight tag (GR, M+, etc...).
- Ends with a <CR>,<LF>.

Print example:

```

          1
123456789012
"      OLB GR"
    
```

"DOWNLD" - *This format is compatible with the original Downloader. It duplicates the standard EZ 210 / EZ 150 print output. The print data is the same even while batching on an EZ3200. It is not the same as the EZ 320 and therefore does not provide the exact same information while batching. Use this selection when connected to a Downloader.*

- Includes weight, display unit, '\$' if unit is "locked-on", weight tag (GR, M+, etc...) date and time.
- Ends with a <CR>,<LF>.

"DT+TM " - *This is a simple comma delimited format.*

- Includes weight, display unit, '\$' if unit is "locked-on", weight tag (GR, M+, etc...) and date.
- Ends with a <CR>,<LF>.

Print example:

```

          1              2              3
123456789012345678901234567890
"      0, LB, , GR, 13MR02, 11:08"
    
```

"ID+TM " - *This comma delimited format includes ID, time but not date.*

- Includes ID, weight, display unit, '\$' if unit is "locked-on", weight tag (GR, M+, etc...) and time.
- Ends with a <CR>,<LF>.

Print example:

```

          1              2              3
123456789012345678901234567890
"      ,      0, LB, , GR, 11:08"
    
```

"IDWTTM" - *This comma delimited format includes ID, time and date.*

- Includes ID, weight, display unit, '\$' if unit is "locked-on", weight tag (GR, M+, etc...), date and time.
- Ends with a <CR>,<LF>.

Print example:

```

          1              2              3              4
1234567890123456789012345678901234567890
" FARM-1, 16090, LB, , GR, 27JA00, 10:37P"
    
```

"ANIMAL" - *This comma delimited format includes information for animal weighing.*

- Includes '\$' if unit is "locked-on", weight, weight tag (GR, M+, etc...), display unit, Memory Weight (RM), Average Count (Number of times M+ key was pressed), Average Weight, Gross weight on scale, ID, date and time.
- Ends with a <CR>,<LF>.

Print example:

```

1         2         3         4
5         6         7         1         2         3         4
12345678901234567890123456789012345678901234567890123456789
01234567890

```

```

"      ,      1400,GR,LB,      2180,      4,      545,
1400,      ,11:09,13MR02"

```

"3200-A" - *This comma delimited format includes information for batching weighing.*

- Includes Preset, Weight, Gross Weight, ID, Ingrid/Pen Name, Recipe#, Batch#, Total Rotation Count, display unit, '\$' if unit is "locked-on", weight tag (GR, M+, etc...), time and date.
- Ends with a <CR>,<LF>.

Print example:

```

1         2         3         4
5         6         7         1         2         3         4
12345678901234567890123456789012345678901234567890123456789
01234567890

```

```

"      1000,      0,      16100,      ,CORN-1, 2,
2,      , 9:35P,27JA00"

```



- "3200-B" - *This comma delimited format includes more information for batching weighing.*
- Includes Manual Advance indicator, Scale ID, Preset, Weight, weight tag (GR, M+, etc...), Gross Weight, display unit, '\$' if unit is "locked-on", ID, Ingrid/Pen Name, Recipe#, Batch#, Total Rotation Count, Time, Date and User ID.
  - Ends with a <CR>,<LF>.

Print example:

```

7           1           2           3           4           5           6
           8           9
12345678901234567890123456789012345678901234567890123456789012345
6789012345678901234567890123
  *,NEW EZ,  1000,    0,NE,  16090,LB, ,    ,CORN-1, 2,
3,    , 9:36P,27JA00,    "
```

- "32-TMR" - *PRELIMINARY! This print format is compatible with the EZ 3500 and allows TMR Tracker & Tracker Lite to store data and create reports. Please Note: TMR Tracker & Tracker Lite CANNOT send recipes to the EZ 3200. This feature is included on the EZ 3500.*
- Starts with specific control codes for TMR Tracker.
  - Includes Scale ID, Line Status, Line Type, Batch#, ID# or Ingrid/Pen name, Recipe#, Preset, Weight, User ID, Time and TMR Style Date.
  - Ends with specific control codes for TMR Tracker.

**6. DDL Set Up Requirements**

Use of the DDL (Data Downloader) with the EZII series indicator requires the latest software version. It is recommended that you call the Digi-Star Service Department for the latest software version and upgrade, if necessary, to become current, before attaching and using a DDL.

Menu 2 in the long form set up contains some features that must be set for the DDL to function properly. They are:

SCOREM	0
COM IN	DOWNLD
C1 DLY	.10

## Appendix A Short Form Calibration

### CALIBRATION

#### Warning!

This indicator was calibrated at the factory to weigh accurately with your system.

Additional calibration is not necessary under normal conditions.

The **Short Form Setup & Calibration** procedure (page 55) allows you to change the “SETUP” and “CAL” numbers of the indicator. You may want to perform this procedure if:

- The indicator is being connected to different load cells, or
- you want to adjust the calibration to match another scale system.

Before continuing, first write down the current SETUP and CAL numbers of your EZ indicator. These numbers are displayed during the Self Test. To run the self test:

With the indicator already ON, press the



key to start the Self Test. Press the



key to "pause" the Self Test while

numbers are displayed. Press the  key again to "resume".

SETUP # \_\_\_\_\_ CAL # \_\_\_\_\_

Keep this information for future reference.

**Note:** Do not attempt to calibrate the scale if the indicator is not reading stable weights. The calibration procedure **will not fix** instability, inconsistencies, or flashing "RANGE" messages.

Press and hold the ZERO key and then press the ON key at the same time.

**Determining the SETUP number**

Weigh Method				
Lb	1	2	3	4
Kg	5	6	7	8
	General	Slow	Fast	Lock-On

Gain (1-9)					
	OLD Max Signal (mV/V)	NEW Max Signal (mV/V)		OLD Max Signal (mV/V)	NEW Max Signal (mV/V)
1	3.0	3.0	6	3.0	3.0
2	1.5	1.5	7	1.5	1.5
3	.75	1.5	8	.75	1.5
4	.75	.75	9	.38	.75
5	.38	.38			

Note: OLD gain settings are for PROG ID – EZII 0A, EZII 0B, and EZII 0C. NEW settings are available for PROG ID EZII 1.0 and higher.

Display Count (0-9)	
Setting on Indicator	Count Size
0	Represents .01, .02, .05 or .1 Select in Long Form Only
1	.2
2	.5
3	1
4	2
5	5
6	10
7	20
8	50
9	100

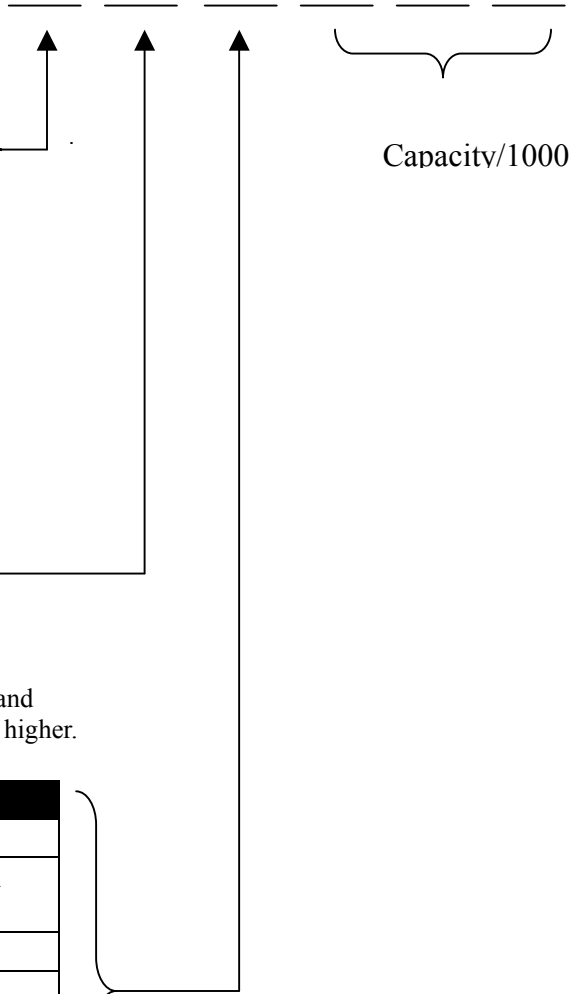

Press the  key for next menu option in Short Form Setup (CAL).

-----  
 -----  
 -----  
 -----  
 -----  
 -----  
 -----  
 -----  
 -----  
 -----  
**Calibration Number (Calibration Weight at 0.4 mV/V)**

**Adjusting the Indicator to Match Another Scale**

Sometimes two different scales are used to weigh the same load. When this is done, the weight measured by each scale may not be the same. This can be caused by one or both of the scales being slightly out of calibration. This indicator has the ability to match any other scale, even if that scale is un-calibrated.

To match your EZ scale (Scale A) to another scale (Scale B) you must determine the Calibration Multiplier. To do this, place a load on Scale A (feed wagon, etc...) and write down the weight displayed. Repeat several times to determine the average weight. Next, place the same load on Scale B and again write down the weight displayed. Repeat several times to determine the average weight.

Use the following formula to determine the Calibration Multiplier for the EZ's "CAL" number:

It is important to use an average of several weights before calibrating the scale.

**Scale Matching Example**

**Original**  
 SETUP# 127060  
  
 CAL# 23980

**Scale Information sheet**

**Original**  
 SETUP \_\_\_\_\_ #  
  
 CAL# \_\_\_\_\_

	1 trial	2 trial	3 trial
<b>Scale B</b>	30,000	30,580	28,000
<b>Scale A</b>	29,440	29,800	27,500
<b>B ÷ A</b>	1.020 + 1.026 + 1.018 = 3.064		
<b>B ÷ A</b>	3.064 ÷ 3 trials = 1.021 Cal Multiplier		

	1 trial	2 trial	3 trial
<b>Scale A</b>			
<b>Scale B</b>			
<b>B ÷ A</b>	+ + =		
<b>B ÷ A</b>	x		
<b>B ÷ A</b>	x ÷ 3 trials = Cal. Multiplier		

New EZCAL# = Orig. EZCAL# × Cal.Multiplier  
 24484 = 23980 × 1.021

New EZ CAL# = Orig. EZ CAL# x Cal. Multiplier

\_\_\_\_\_ = \_\_\_\_\_ x \_\_\_\_\_

You should not modify your "SETUP" number. Only your "CAL" number. Follow the instructions: *To Change the Setup/Calibration Numbers.*

**Connecting EZ Indicator to Other Load Cells**

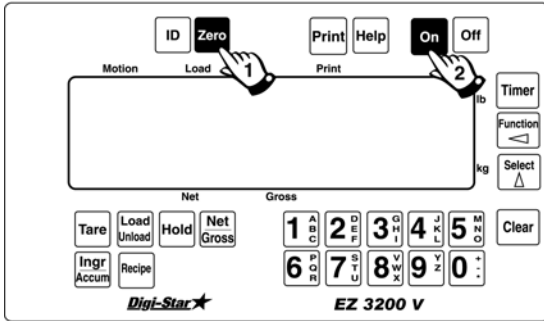

You will need the number and type of loadcells used in the new scale system. You will also need the current "SETUP" and "CAL" as described above. Once you have written down this information, contact the nearest Scale Service Center for new "SETUP" and "CAL" numbers.

Follow the instructions "To Change the Setup / Calibration Numbers".

**To Change The Setup & Calibration Numbers**

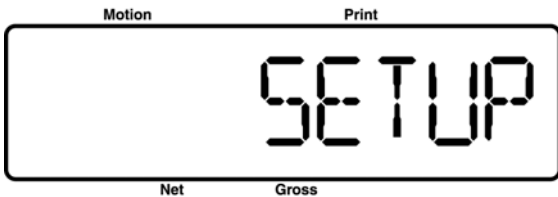
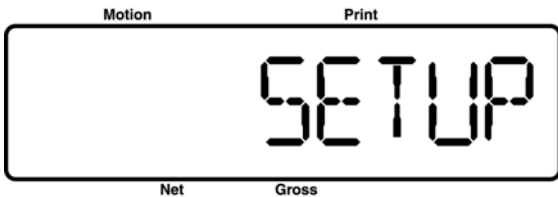

Press and hold the **Zero** key, then press the **On** key, to enter Short Form Setup & Calibration.

The first message displayed is SETUP.

Next, the actual SETUP number is displayed.

**Note:** Press the **Zero** key for additional help information during Setup and Calibration.

If the correct SETUP number is displayed, press the **On** key to advance to the CAL number.

1. Press the **Select** key to cause the “flashing” digit to count upward.
2. Press the **Function** key to select which digit is flashing.

When the correct SETUP number is displayed, press the **On** key to advance to the CAL number. This displays the CAL message, followed by the CAL number.

**Note:** The CAL number is not a weight. It is a reference value the indicator uses to determine the weight. This number directly affects the accuracy of the scale system.

Change the CAL number using the same method described in Steps 1& 2. When the display shows the correct number, press the **On** key. This causes the number to be stored permanently in the indicator and returns the indicator to the weighing mode.

**To Return To Weigh Mode**

To exit setup without changing the displayed value, press and hold the **Tare** key, then press the **On** key.

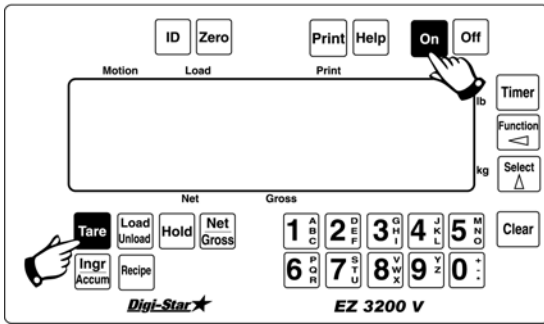



## Appendix B Weigh Method Descriptions

Different *electronic* techniques or “Weigh Methods” are used in an attempt to better fit the weighing application. The EZ Scale Indicators provide three (4) different methods:

Setting	Characteristic
1	General
2	Slow
3	Fast
4	Lock-On

Weigh methods 1, 2, & 3 are suitable for weighing dead weights and weigh method 4 is for weighing live animals.

### General - Weigh Method #1

The *General* weigh method is the *all-purpose* weigh method. It is used for most applications. *General* is similar to the weigh method used on *Models 5, 10, 15, & 20*. A comparison would be a *Model 10* with a TC (Time Constant) of 4.

### Slow - Weigh Method #2

The *Slow* weigh method attempts to provide higher accuracy by filtering many weight samples over a longer period of time. Small, instantaneous *weight changes* have less effect on the displayed weight using this technique.

### Fast - Weigh Method #3

The *Fast* weigh method is more sensitive to weight changes than the other weigh methods. When a weight changes quickly, the *Fast* method tries to determine the new weight as quickly as possible. This is done by providing less filtering during the actual “*weight change*.” When the weight begins to stabilize, filtering is increased to provide an accurate weight display.

### Lock On - Weigh Method #4

The *Lock On* weigh method allows scale to weigh active animals and display an accurate weight that does not fluctuate.. Lock-On sensitivity can be adjusted using the “LOCKON” menu.

Once the actual weight is displayed, the scale “Locks-On” to the displayed. Weight does not change, even if the motion never stops. A small ‘L’ appears on the left side of the display indicating the weight is “Locked-On.” The animal’s weight must be greater than 2.5% of the scales “capacity” weight before the system can “Lock-On.”

In order to break the lock, 50% of the displayed weight must be either added or removed from the scale. The “Locked-On” weight can be “rechecked” by pressing the [ZERO] key on the front panel. This breaks the “lock” and the scale recalculates the weight.

Note: In Weigh Method #1, #2 and #3 the ZTRACK (zero-tracking) removes up to 0.05% of the scale capacity (as shown in setup). In Weigh Method #4 the weight that can be removed is set to 5lbs(2.2kg).

**Adjustment Options for Weigh Methods #1 and #2**

Adjustment options in Menu #3 of the Long Form Setup allow the operator to adjust the fintering characteristics of Weigh Methods #1 (General) and #2 (Slow). These adjustments change how the scale processes the weight signal received from the load cells. The scale samples a new weight signal 10 times per second, which is every 100 milli-seconds.

The Weigh Method adjustment options are set in Menu #3 of the Long Form Setup. Weigh Method options (W MTHD) are selected in Menu #1 of the Long Form Setup.

Changing the Display Rate also effects how the weight appears on the scale. A selection of '1' update per second helps to stabilize the weight. A selection of '4' updates per second provides more response to weight changes, but may cause the weight to appear "jumpy". The Display Rate is set to 2 at the factory. The Display Rate adjustment is set in Menu #1 of the Long Form setup.

**Weigh Method #1 - General, has three adjustments found in Menu #3.**

*Weigh Method #1 - Adjustment 1("WM1-A1")* can be set from 2 - 100 (factory setting = 10).

Adjustment 1 is the main "filter" setting for the weigh method. A small filter number like 2 or 4 causes the scale to respond quickly to weight changes, but may cause the display to appear "jumpy". A large filter number like 32 or 64 causes the scale to be more stable, but is "slow" to respond to weight changes.

*Weigh Method #1 - Adjustment 2("WM1-A2")* can be set from 0 - 100 (factory setting = 4).

When Adjustment 2 is set to a value other than 0 it activates a "Quick Response" feature. This allows the scale to quickly respond to large weight changes. When the weight changes, the scale first determines how much change has occurred before it processes the weight.

Weight changes less than the weight value entered in WM1-A3 (see below) will use the filter number set in WM1-A1 to determine the displayed weight.

Weight changes greater than the weight value entered in WM1-A3 will use the "Quick Response" filter number set in WMA1-2 until the displayed weight gets close to the actual weight. Once close to the actual weight, Weigh Method #1 uses the filter number set in WM1-A1.

In WM1-A2, a small filter number like 2 or 4 will cause the scale to respond quickly to large weight changes. A large filter number like 32 or 64 will cause the scale to be more stable and less responsive to weight changes greater than the amount set in WM1-A3.

*Weigh Method #1 - Adjustment 3("WM1-A3"):*

Adjustment 3 sets the "Quick Response Weight" for Weigh Method #1. If the weight added to the scale is greater than this amount, the "Quick Response Average Number" setting of WM1-A2 is used as the filter number. The default is 10% of the scale's capacity. For example, if this value is set to 3000, then the weight must change more than 3000 lbs before Weigh Method #1 will use the "Quick Response Average Number" set in WM1-A2. Once close to the actual weight, Weigh Method #1 uses the filter number set in WM1-A1.

**Weigh Method #2 - Slow, has three adjustments:**

*Weigh Method #2 - Adjustment 1("WM2-A1")* can be set from 2 - 100 (factory setting = 30) :

Adjustment 1 is the "Maximum Average Number" setting for the weigh method. This number determines how many of the previous weight samples to average. A small average number like 2 or 4 causes the scale to respond quickly to weight changes, but may cause the display to appear as "jumpy". A large average number like 32 or 64 causes the scale to be more stable, but is "slow" to respond to weight changes.

*Weigh Method #2 - Adjustment 2("WM2-A2")* can be set from 0 - 100 (factory setting = 10) :

Adjustment 2 is the "Quick Response Average Number" setting for the weigh method. If Adjustment 2 is set to a value other than 0 it activates the "Quick Response" feature. This allows the scale to quickly respond to large weight changes. When the weight changes, the scale first determines how much change has occurred before it processes the weight.

Weight changes less than the weight value set in WM2-A3 cause the scale to use the filter number set in WM2-A1 to determine the displayed weight.

Weight changes greater than the weight set in WM2-A3 cause the scale to use the "Quick Response Average Number" set in WM2-A2 until the displayed weight gets close to the actual weight. Once close to the actual weight, Weigh Method #2 increases the Quick Response Average Number on each conversion until the number of averages equals the Maximum Average Number set in WM2-A1.

In WM2-A2, a small number like 2 or 4 will cause the scale to respond quickly to weight changes greater than the amount set in WM2-A3. A large filter number like 32 or 64 will cause the scale to be more stable and less responsive to weight changes greater than the amount set in WM2-A3.

*Weigh Method #2 - Adjustment 3("WM2-A3"):*

Adjustment 3 sets the "Quick Response Weight" for Weigh Method #2. If the weight added to the scale is greater than this amount, the "Quick Response Average Number" setting of WM2-A2 is used as the filter number. The default is 10% of the scale's capacity. For example, if this value is set to 3000, then the weight must change more than 3000 lbs before Weigh Method #2 will use the "Quick Response Average Number" set in WM2-A2. Once close to the actual weight, Weigh Method #2 increases the Quick Response Average Number on each conversion until the number of averages equals the Maximum Average Number set in WM2-A1.

**Appendix C Long Form Setup and Calibration**

Press and hold the **Net Gross** key and then press the **On** key at the same time. Wait until indicator beeps. To exit the Long Form Setup, press the **Tare** key and the **On** key at the same time. The following is a list of parameters (settings to change) available in the Long Form Setup. See Long Form Setup for a detailed explanation of each parameter structure for access.

*Please note: Settings will only be displayed if their feature is found in the indicator model.*

**Menu 1 - Basic features in all scales**

LANGUAGE {LANGAG}	101	Select Language to be displayed.
DISPLAY RATE {D RATE}	102	Update Display 1, 2, 3, or 4 Times per Second.
MOTION {MOTION}	103	If ON - motion arrow flashes for unstable weight.
ZERO TRACK {ZTRACK}	104	If ON – Zero Track adjusts zero/balance for build up of snow and mud.
WEIGH METHOD {W MTHD}	105	Select weigh method 1-General 2-Slow 3-Fast 4-Lock-On
LOCK ON {LOCKON}	106	Decrease number if lock-on does not repeat - increase number to lock-on faster.
TR HOLD {TR HLD}	107	Display gross weight if TR key is held for 3 seconds.
SCALE ID SETUP {SCALID}	108	Allow Operator to identify the scale location (Truck ID or Mixer Number).
LOCK-N-HOLD {LKNHLD}	109	If ON-lock weight is held until next animal is weighed.
AUTO-OFF {AUTOFF}	111	Indicator turns off after selected minutes of stable weight.

**Menu 2 - Clock, Printer & Estimated Weight Features**

**Clock features**

TIME FORMAT {TIME F}	201	Select time format - AM/PM or 24 hour
TIME {TIME}	202	Press and hold Select key to change time - Function key chooses hh:mm:ss.
DATE FORMAT {DATE F}	203	Select date format 1-mm-dd 2-mm/dd/yy 3-mm/dd/yyyy 4-dd-mm 5-dd/mm/yy 6-dd/mm/yyyy 7-ddmoyy 8-ddmoyyyy.
DATE {DATE}	204	Press and hold Select key to change date - Function key chooses mm/dd/yy

**Print features**

TARE AUTO PRINT {TAREAP}	211	If ON - tare will auto-print displayed weight.
ONE LINE PRINT {1L PRT}	212	If ON - scale data will be printed on one line.
SCOREBOARD MODE {SCOREM}	213	Select scoreboard output mode 1-1/sec 2-2/sec 3-3/sec 4-every conversion 5-display rate 6-display weight change.
AUTO PRINT {APRINT}	214	If ON - pressing keys will auto-print weight values.
COMPUTER IN MODE {COM IN}	215	Select computer input mode DOWNLD = data down loader EZ CMD = ez computer commands.
PRINT WEIGHT ONLY {WTONLY}	216	If ON - Scale only prints weight value.
PRINT FORMAT {prfmt}	216	Select alternate and comma (CSV) formats - auto is standard format.
MEDIA TYPE {MEDIA}	217	Select DDL or Datakey for data storage.
COM 1 DELAY {C1 DLY}	221	Select seconds to delay before advancing to next line (was PRT DLY).
COM 2 DELAY {C2 DLY}	222	Select seconds to delay before advancing to next line.
ESTIMATE WEIGHT {EST WT}	299	Allows operator to adjust Gross weight of scale by changing the zero/balance.

**Menu 3 - Scale Calibration Settings**

DISPLAY COUNT {COUNT}	301	Select display count size of weigh values.
-----------------------	-----	--

AUTO RANGE { <i>ARANGE</i> }	302	If ON - display count automatically adjusts the count value by addition of 1 display count at 300 lbs/kgs and 1 display count at 600 lbs/kgs.
DISPLAY UNIT { <i>LB-KG</i> }	303	Display pounds - lb or kilograms - kg
CAPACITY { <i>CAP</i> }	304	Enter MAXIMUM weight measurable on scale.
WM1 ADJUST 1 { <i>WMA1-1</i> }	305	Increase this number to smoothen weighing
WM1 ADJUST 2 { <i>WMA1-2</i> }	306	Enter a value less than WMA1-1 for quick weight response, 0=OFF.
WM1 ADJUST 3 { <i>WMA1-3</i> }	307	Enter the weight to activate quick weight response.
WM2 ADJUST 1 { <i>WMA2-1</i> }	311	Increase this number to smoothen weighing
WM2 ADJUST 2 { <i>WMA2-2</i> }	312	Enter a value less than WMA2-1 for quick weight response, 0=OFF.
WM2 ADJUST 3 { <i>WMA2-3</i> }	313	Enter the weight to activate quick weight response.

**Menu 4 - Batching Features**

**Preset features**

PRE ALARM { <i>P-ALM</i> }	401	Early warning that scale is reaching the preset. Pre-alarm value can be calculated by weight or percentage.
REMOTE INPUT { <i>RM INP</i> }	402	Set function of remote input line on the power cord.
ALARM OUTPUT { <i>AL OUT</i> }	403	Select Preset OR TR to control Relay, Horn & Lamp.
BUZZER { <i>BUZZER</i> }	404	ALARM BUZZER - Allows user to turn OFF Alarm Horn.
PRELOAD TARE { <i>PRETAR</i> }	405	If ON - tare weights can be entered using the numeric keypad
PRESET AUTO CLEAR { <i>PRECLR</i> }	406	If ON - disables preset after 45 minutes if weight does not change.

**Mix Timer / Rotation Counter features**

TIMER/COUNTER { <i>TMRCTR</i> }	421	Select time or mixer revolutions to decrement mix timer/counter.
DRIVE RATIO { <i>DRATIO</i> }	422	Enter the number of input pulses that equal 1 mixer revolution.

**Batching features**

ENTRY METHOD { <i>E MTHD</i> }	441	Select batching entry method 1-amount/animal 2-percent/load 3-amount/load.
TOLERANCE { <i>TOLER</i> }	442	Select tolerance weight percentage to accept ingredient.
INGR.ADVANCE DELAY { <i>DELAY</i> }	443	Select seconds to delay before advancing to next ingredient.
INGREDIENT NAMES { <i>INGRNM</i> }	444	If ON - displays ingredient names while batching.
ACCUMULATION { <i>ACCUM</i> }	445	If ON - ingredient weights are accumulated while batching.
FORCE USER ID { <i>USERID</i> }	446	If ON - operator MUST enter User ID to use scale.
MEDIA STORAGE { <i>mstore</i> }	447	Select <b>MANUAL</b> , <b>AUTO</b> or <b>QUICK START</b> method for transferring recipe information with the <b>DDL</b> or <b>Datakey</b> ..
RESIZE 3500 RECIPE { <i>resize</i> }	448	If ON - operator can change EZ3500 recipe size.
INGREDIENT RESIZING { <i>INGSIZ</i> }	449	Selects automatic ingredient re-sizing mode.
RECIPE TOTAL { <i>RECTOT</i> }	451	Selects total amount to be displayed when starting recipe.
DISPLAY SCOOP% { <i>SCOOP%</i> }	452	If ON - Displays scoop percentage to load.
TOLERANCE LOCK { <i>overlk</i> }	453	If ON - Prevents auto-advancing if amount exceeds tolerance.

**Auto-Error Detection feature.**

AUTO ERROR { <i>AERROR</i> }	499	If ON - notifies operator of system errors.
------------------------------	-----	---

**CALIB - CALIBRATION.**

TEMP CALIBRATION { <i>T CALB</i> }	801	If ON - scale adjust for temperature changes.
DEAD WEIGHT CAL { <i>CAL</i> }	802	Calibration method using weights.

**SHORT FORM - CALIBRATION SETTINGS.**

SETUP NUMBER { <i>SETUP</i> }	871	Quick entry value to select weigh method (1-4 lb) (5-8 kg), gain (1-9), display counts (0-9), and capacity (*1000)
CALIBRATION NUMBER { <i>CAL</i> }	872	Weight that would be displayed at 0.4mV/V for these loadcells.

## Appendix D Self Test Error Messages

If system errors are discovered during the Self Test, the following error message is displayed:

1. “ERROR // Press NET/GROSS to Continue”  
(Where  $N$  = an error number, see list below.)
2. After pressing the  key, the next message displayed is “\*\*\*INDICATOR NEEDS SERVICE\*\*\*PRESS NET/GROSS TO CONTINUE.”

*Please note the following:*

- If the Scoreboard option is installed and the Scoreboard mode is set to #5 or #6 , the scale sends the message “TEST” on the scoreboard data line.
- Sending a command using the Computer Interface causes the system to skip the error messages and attempt normal system operation.
- The test cannot be terminated while the “RUNNING SELF TEST – PLEASE WAIT” message is displayed.

## Error Descriptions

Please note that broken circuit board solder joints or opens to the IC sockets can also cause these errors.

### **Error 1: EPROM FAILURE – Replace I.C. U104**

If this error occurs, the program memory device (Type 27C020) is defective. A CRC (Cyclic Redundancy Check) is performed on the internal software program that runs the scale. This is similar to a “check sum” and is used to test the integrity of the program stored in the EPROM.

U104 is located on the **Main Board** and is the Integrated Circuit (I.C.) that contains the program EPROM.

### **Error 2: 68HC12 SYSTEM CRC EEPROM FAILURE – Replace I.C. U101**

If this error occurs, the system setup data stored in the microcontroller (68HC12) has changed unexpectedly. A CRC (Cyclic Redundancy Check) is performed on the non-volatile system setup parameters stored in the microcontroller’s internal EEPROM. This is similar to a “check sum” and is used to test the integrity of the data stored in the EEPROM. The scale keeps track of this value and tests the EEPROM during the self test. This error occurs because a value has changed from it’s original saved version.

U101 is located on the **Main Board** and is the Integrated Circuit (I.C.) that contains the EEPROM setup parameters.

**Error 3: 68HC12 RAM FAILURE – Replace I.C. U101**

If this error occurs, the microcontroller (68HC12) that runs the scale is defective. A data error was found while testing the microcontroller's internal RAM (Random Access Memory). Several different write/read operations are performed on each RAM location to detect a failed part.

U101 is located on the **Main Board** and is the Integrated Circuit (I.C.) that contains the 68HC12 RAM.

**Error 4: EXTERNAL RAM FAILURE – Replace I.C. U102**

If this error occurs, the data memory device (Type 62256) is defective. A data error was found while testing the external RAM (Random Access Memory) device. Several different write/read operations are performed on each RAM location to detect a failed part.

U102 is located on the **Main Board** and is the Integrated Circuit (I.C.) that contains the external RAM.

**Error 5, 6, or 7: 68HC12 SCALE CRC EEPROM FAILURE – Replace I.C. U101**

If this error occurs, the scale setup data stored in the microcontroller (68HC12) for a specific "scale platform" has changed unexpectedly. Most indicators only support 1 scale platform: scale platform "A".

Error #5 is displayed for failures on scale platform "A".

Error #6 is displayed for failures on scale platform "B".

Error #7 is displayed for failures on scale platform "C".

A CRC is performed on the non-volatile scale setup parameters stored in the microcontroller's (68HC12) internal EEPROM. It is similar to a "check sum" and is used to test the integrity of the data stored in the EEPROM. The scale keeps track of this value and tests the EEPROM during the self test. \

U101 is located on the **Main Board** and is the Integrated Circuit (I.C.) that contains the EEPROM setup parameters.

**Error 8,9, or 10: ANALOG CONVERTER FAILURE – Test I.C. U3**

If this error occurs, the microcontroller (68HC12) cannot receive analog-to-digital (A/D) counts from a specific "scale platform." Most indicators only support one (1) scale platform: scale platform "A".

Error #8 is displayed for failures on scale platform "A".

Error #9 is displayed for failures on scale platform "B".

Error #10 is displayed for failures on scale platform "C".



U3 is located on the **Main Board** and is the Integrated Circuit (I.C.) that converts the signal coming from the loadcell, into digital information that the microcontroller can read.

**Error 11: REAL TIME CLOCK MISSING – Install DS1744 at I.C. U102**

If this error occurs, the microcontroller (68HC12) could not find the Date and Time Registers of the Real Time Clock (Type DS1744) which replaces the RAM chip (Type 62256) at location U102. If the Real Time Clock *is* installed, verify the jumpers X1, X2, X3, and X4 for proper configuration.

U102 is located on the **Main Board** and is the Integrated Circuit (I.C.) that contains the external RAM and in this case, the Real Time Clock.

**Error 12: REAL TIME CLOCK BATTERY FAILURE – Install NEW DS1744 at I.C. U102**

If this error occurs, the microcontroller (68HC12) detected an internal battery failure in the Real Time Clock (Type DS1744) at location U102. The battery is not accessible so the entire Real Time Clock chip must be replaced.

U102 is located on the **Main Board** and is the Integrated Circuit (I.C.) that contains the Real Time Clock.

**Error 13: KEYPAD OVERRUN FAILURE**

If this error occurs, keys on the front panel, or the TR unit, have been pressed so many times that the microcontroller (68HC12) simply cannot identify any more keystrokes. This failure is rare and can usually be resolved by turning off the indicator for 5 seconds. This error should not re-occur unless multiple keys are being activated at a very rapid pace.

**Error 14: COMM PORT #1 INPUT BUFFER OVERFLOW ERROR**

If this error occurs, the computer attached to Port #1 has sent too many characters to the indicator. When the input buffer of the scale is full and cannot receive any more data, the input buffer stops taking data and activates this error.

**Error 15: COMM PORT #1 PRINTER OUTPUT BUFFER OVERFLOW ERROR**

If this error occurs, the indicator has tried to print too many characters. When the output buffer of the scale is full and cannot transmit any more data, the output buffer stops taking data and activates this error.

**Error 16: COMM PORT #1 SCOREBOARD OUTPUT BUFFER OVERFLOW ERROR**

If this error occurs, the indicator has tried to send out too much data to the scoreboard. When the output buffer of the scale is full and cannot transmit any more data, the output buffer stops taking data and activates this error.

**Error 17: COMM PORT #2 INPUT BUFFER OVERFLOW ERROR**

If this error occurs, the computer attached to Port #2 has sent too many characters to the indicator. When the input buffer of the scale is full and cannot receive any more data, the input buffer stops taking data and activates this error.

**Error 18: COMM PORT #2 OUTPUT BUFFER OVERFLOW ERROR**

If this error occurs, the indicator has tried to transmit too many characters. When the output buffer of the scale is full and cannot transmit any more data, the output buffer stops taking data and activates this error.

**Error 19 and 20: SPI FAILURE**

This error indicates that the high speed internal Serial Peripheral Interface (SPI) of the microcontroller (68HC12) has failed. This interface connects the microcontroller to the LCD drivers and the A/D converter.

**Error 21, 22, and 23 A/D 0.4mv/V CALIBRATION FAILURE**

If this error occurs, the 0.4 mv/V gain calibration was not performed for a specific "scale platform." Most indicators only support one (1) scale platform: scale platform "A".

Error #21 is displayed for failures on scale platform "A".

Error #22 is displayed for failures on scale platform "B".

Error #23 is displayed for failures on scale platform "C".

This error occurs because the 0.4 mv/V gain calibration was not performed.

**Error 24**

This error indicates that the high speed internal Serial Peripheral Interface (SPI) of the microcontroller (68HC12) resumed communication with the software program before the A/D "data-ready" line was activated by the A/D converter. The indicator cannot perform weight measurements without receiving the "data-ready" line from the A/D converter and will display AD-ERR.

**Key Locations and Switch Numbers**

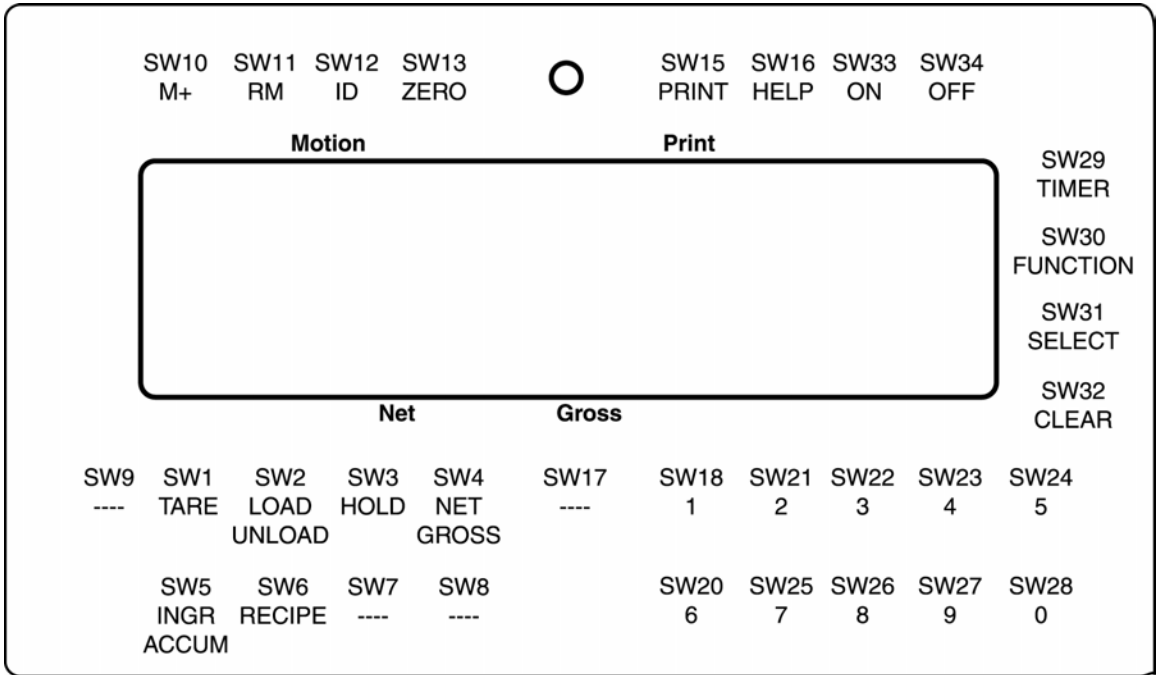

**Keypad Failure Error Codes**

If a keypad failure is detected when the system is first turned On, the following error message is displayed: “KEYPAD FAILURE.” This error is followed by an error code.

Locate the error code in the table below to determine which key is being held on.

Error Code	Key Held	Switch Number	Scan Line	Key Input
10	NET/GROSS	4	0	0
11	---	8	1	0
12	ID	12	2	0
13	HELP	16	3	0
14	6	20	4	0
15	5	24	5	0
16	0	28	6	0
17	CLEAR	32	7	0
20	HOLD	3	0	1
21	---	7	1	1
22	RM	11	2	1
46	#7	25	6	3
47	TIMER	29	7	3

**Additional Error Codes:**

08=ON key is pressed



53=RMZ Signal (Remote Input from power cord) at zero (0) volts DC.

54=!INIT line (pin 6 of J3 on Main circuit board) at zero (0) volts DC.

56=OPTO 2 signal at zero (0) volts DC.

**Initiating Key Test**



The keys on the front of the indicator can be tested using the “Key Test.”

1. To start the key test, wait until normal scale operation has begun.
2. Press and hold the  key, the [HOLD] key, and the  key until the following message is displayed:

“KEY TEST – KEYS BEEP WHEN PRESSED – PRESS ON TO EXIT”

This test will cause the indicator to beep and display the error code (above) whenever a key is pressed.

**Terminating the Test**

Terminate the self test by pressing the  key. Once the  key has been pressed, normal operation continues.

## Appendix E - Operating the Mix Counter Feature

The Digi-Star Electronic Scale Indicator and Digi-Star Loadcells are used to provide weigh measurements. The Indicator has an alpha-numeric display to provide the weight values and a keypad to allow the operator to perform different operations.

The Timer/Counter (Mix Counter) feature will display mixer auger revolutions based on input pulses from a revolution-sensing device and an adjustable drive ratio that indicates how many pulses equal one (1) mixer revolution.

### Purpose

Feed Mixers in the agricultural market are used to mix or blend a variety of forage products (such as hay, corn, cotton seed, etc.) before delivering it to livestock as feed. The Mix Counter feature will help to prevent "over-mixing" of these forage materials. Over-mixing occurs when the feed mixer runs too long and causes the forage materials to be "cut or ground" into small particles which are undesirable.

Another benefit of the Mix Counter feature is its ability to help indicate when the feed mixer requires maintenance by keeping track of all mix auger revolutions. Knowing how many times the mix auger(s) have revolved will help ensure that maintenance on the feed mixer occurs at proper intervals. This should also help extend the useful life of the feed mixer.

### Setup and Drive Ratio Determination

The Mix Counter works similar to the current Mix Timer. Instead of counting time (as with the Mix Timer) the Mix Counter counts down the number of mixer revolutions. The operator enters the number of mixer revolutions prior to using the Mix Counter feature. The Mix Counter feature activates alarms to notify the operator when the mixer has revolved the number of times entered.

To setup the mix counter, you must set the drive ratio (DRATIO) and the Mix Counter (MIXCTR) in the Long Form Setup and Calibration.

**To Set the Drive Ratio**

The “Drive Ratio” is a number that tells the indicator how many pulses equal 1 mixer revolution. The Drive Ratio can be any number ranging from 0.01 to 999.99.

The Drive Ratio allows the sensor to be placed on a drive shaft that rotates the auger at a rate other than 1:1.

The Drive Ratio (DRATIO) is entered in the Long Form Setup and is also stored in non-volatile memory. See *Long Form Setup and Calibration*.

The displayed mixer revolutions are most accurate when the Drive Ratio is a whole number such as 1.00 or 50.00. If the Drive Ratio is set as a fraction, such as 6.63 or 27.50, the Mix Counter may have a total mix revolution error of +/- 1 pulse. This occurs because the Mix Counter determines the displayed revolution count by dividing the number of pulses by the Drive Ratio. The Mix Counter is displayed “REVxxx” and is rounded to the nearest whole revolution (REV). For example, a drive ratio of 6.63 will display “REV 1” after 7 pulses ( $7\text{pulses}/6.63=1.055$  or 1 when rounded) and “REV 9” after 60 pulses ( $60\text{pulses}/6.63=9.049$  or 9 when rounded).

### To Setup the Mix Counter

To set the mix counter number of revolutions, use the Timer/Counter setting in the Long Form Setup and Calibration. See *Long Form Setup and Calibration*.

The number of revolutions can range from 1 to 999 and is activated using the [TIMER/COUNTER] key. This key may be a dedicated key on front panel or if no key is available, the [FUNCTION] key can be set to perform this operation.

If a [TIMER/COUNTER] key exists on the front panel, the Timer/Counter setting in the Long Form Setup and Calibration **must** be set to “REV.” This enables the [TIMER/COUNTER] key on the front panel to activate the **Mix Counter** feature and count by mixer revolutions rather than by seconds.

### Installing the Proximity Sensor

The “Input Pulses” for the Mix Counter come in on the Remote Input line (blue wire) of the power cord by momentarily connecting Remote Input line to 0 VDC (ground). A proximity sensor senses a target (attached to a rotating shaft) to sense the rotation of the mixer apparatus.

The proximity sensor must be rated at a minimum of 12 VDC at 20 milli-amps. As the target passes the proximity sensor, it will connect the blue wire in the power cord with 0 VDC (ground) and create the pulse. It is important to install the target & sensor correctly to insure accurate counting. The frequency of the pulses should not be greater than approximately 1500 Revolutions Per Minute. These pulses will be counted by the indicator and stored in non-volatile memory. The Remote Input line of the indicator must be set to Mix Counter (MIXCTR) in the Long Form Setup & Calibration to activate the feature.

Digi-Star offers a reliable solid-state proximity sensor kit PN 404011 (without bracket).

7. Appendix F Serial Cable Drawings

KEY	QTY	PART NUMBER	DRWG. NO.	DESCRIPTION
1	1	A141603		TUBING, HEAT SHRINK 3/4"
2	1	A141607		CONN. HOOD, SERIES 1
3	1	B145330		CONN., CHAS/F 25 PIN D-SUB
4	1	B141650		CONN. HOOD, D-SUB
5	RECD	A141820		CABLE, 4-COND W/SHIELD
6	3	A141642		TUBING, HEAT SHRINK 1/16"
7	1	A840500		TUBING, HEAT SHRINK 3/8"
8	3	B40552		CONN. PIN/F SERIES 2
9	1	B40553		CONN. BODY/M 8-PIN SERIES 2
10	2	A145316		WIRE, BARE, 24 GA, SOLID

**ASSEMBLY INSTRUCTIONS**

- CUT OUTER JACKET TO LENGTH SHOWN.
- CLIP UNUSED RED WIRE & SHIELD WIRE.
- STRIP WIRE ENDS TO LENGTH SHOWN.
- CRIMP PINS, KEY 8, ON WIRE ENDS.
- INSERT PINS INTO KEY 9, USING TABLE 1.
- PLACE HEAT SHRINK TUBING, KEY 1 & KEY 7, OVER CABLE.
- PLACE HEAT SHRINK TUBING, KEY 6, OVER EACH WIRE AND SOLDER WIRE TO KEY 3, USING TABLE 2.
- CUT JUMPERS FROM BARE WIRE, KEY 10. INSTALL AND SOLDER IN PLACE USING TABLE 2. REMOVE EXCESS FLUX FROM KEY 3.
- SHRINK TUBING OVER SOLDER JOINTS & CONNECTOR, KEY 2.
- INSTALL PROTECTIVE CONNECTOR HOOD, KEY 4.

**TABLE 1**

WIRE	PIN NO.	FUNCTION
BLACK	6	SIGNAL GROUND
GREEN	3	DATA TO SCALE
WHITE	2	DATA FROM SCALE
RED	1	NOT USED
SHIELD	NOT USED	

**TABLE 2**

WIRE	PIN NO.	FUNCTION
BLACK	7	SIGNAL GROUND
GREEN	2	DATA TO SCALE
WHITE	3	DATA FROM SCALE
RED	NOT USED	
SHIELD	NOT USED	
BARE	4,5	JUMPER
BARE	6,8,20	JUMPER

**VIEW A-A**  
SCALE 2" = 1"

**VIEW B-B**  
SCALE 2" = 1"

**VIEW C-C**  
SCALE 2" = 1"

  

REV NUMBER	DESCRIPTION OF CHANGE	DATE	CK'D	DO NOT SCALE
F	14832 ADDED KEY 5, CHANGED PART DESCRIPTION	06/20/83	Δ/B	
E	12170 KEY 3 & 4 PIN #'S NUMBERED IN ERROR	06/17/81	Δ/B	
D	10980 TABLE 2 OR 4 WH WIRE FUNC. REVERSED	06/09/80	Δ/B	
C	10613 SELECTED KEY 3 41820	02/28/80	Δ/B	
B	9383 KEY 5 141820 QTY MIS 5"	03/20/78	Δ/Z	
A	88-43 RELEASED	10/20/68		

		TOLERANCE UNLESS NOTED SCALE 1/2" = 1" FINISH UNLESS NOTED MACH. FINISH	
J-STAR INDUSTRIES, INC. 801 JAKESVILLE AVENUE FORT ATKINSON, WY 53538		DRAWING TITLE CABLE, J-STAR RS232 TO DTE	
WEIGHT _____ MATERIAL _____		SHEET 1 OF 1 DRAWING NUMBER 145081	



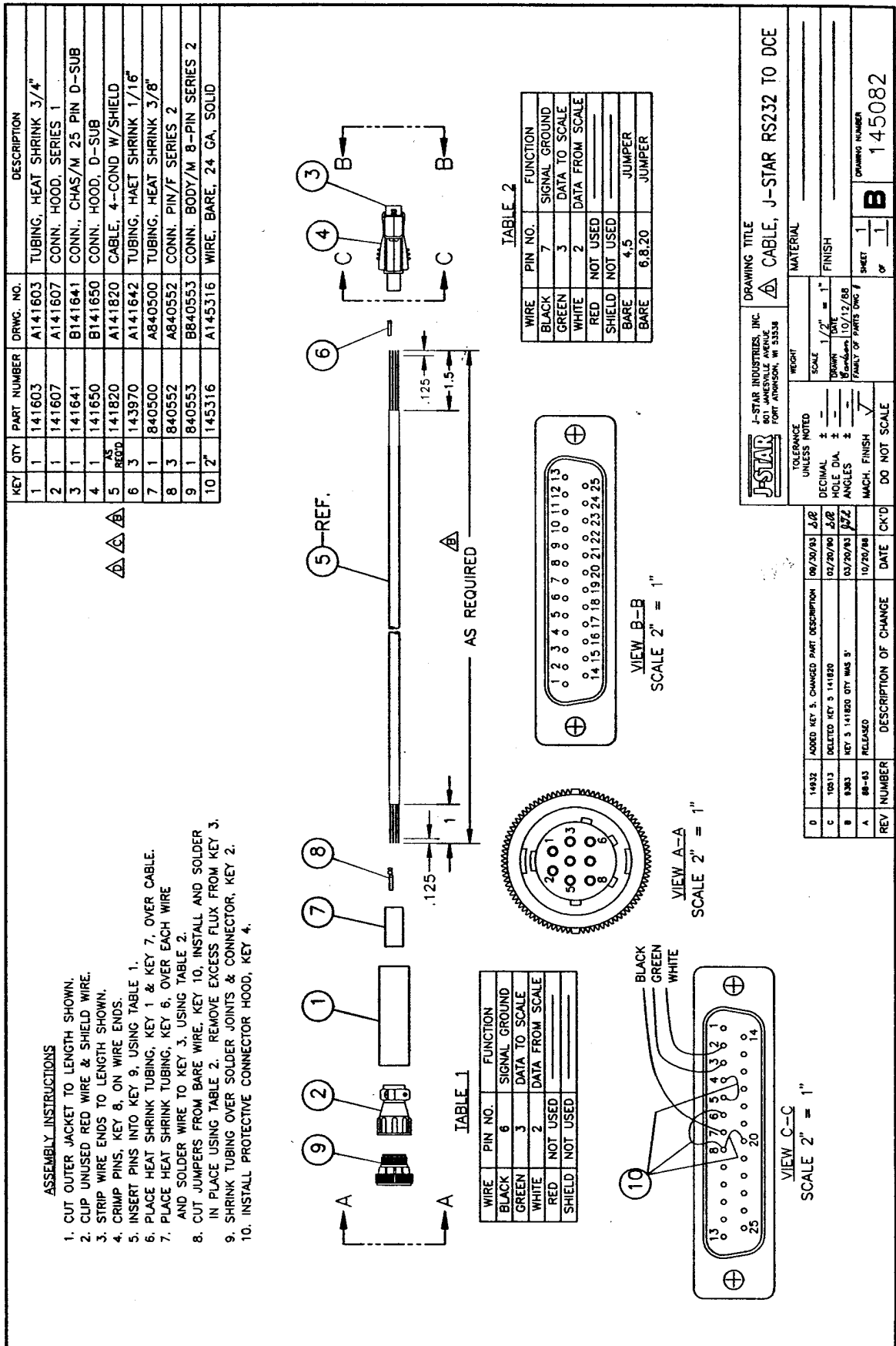

KEY	QTY	PART NUMBER	DRWG. NO.	DESCRIPTION
1	1	141603	A141603	TUBING, HEAT SHRINK 3/4"
2	1	141607	A141607	CONN. HOOD, SERIES 1
3	1	141820	A141820	CABLE, 4-COND W/SHIELD
4	1	840500	A840500	TUBING, HEAT SHRINK 3/8"
5	3	840552	A840552	CONN. PIN/F SERIES 2
6	1	840553	B840553	CONN. BODY/M 8-PIN SERIES 2

**ASSEMBLY INSTRUCTIONS**

1. CUT OUTER JACKET TO LENGTH SHOWN.
2. CLIP UNUSED RED WIRE & SHIELD WIRE.
3. STRIP WIRE ENDS TO LENGTH SHOWN.
4. INSERT PINS INTO KEY 6, USING TABLE 1.
5. PLACE HEAT SHRINK TUBING OVER CONNECTOR HOOD, KEY 2.
6. CABLE. SHRINK TUBING OVER CONNECTOR HOOD, KEY 2.

VIEW A-A  
SCALE 2" = 1"

TABLE 1

WIRE	PIN NO.	FUNCTION
WHITE	2	PRINTER DATA
GREEN	3	DATA TO SCALE
RED	4	RS232 SCOREBOARD DATA
BLACK	6	SIGNAL GROUND
SHIELD	NOT USED	

  
  

REV	NUMBER	DESCRIPTION OF CHANGE	DATE	CAVD
C	14932	ADDED KEY 3, CHANGED PART DESCRIPTION	09/20/83	JLB
D	10813	DELETED KEY 3 141820	02/20/90	JLB
C	8383	KEY 3 141820 QTY WAS 5'	03/20/88	JZZ
B	8686	CHANGED QTY, KEY 6 FROM 1 TO 3	07/07/87	
A	88-43	RELEASED	10/12/88	

	I-STAR INDUSTRIES, INC. 801 JAMESVILLE AVENUE FORT ATKINSON, WI 53538	DRAWING TITLE CABLE, RS232 TO USER CONN.
	WEIGHT _____ SCALE _____ DECIMAL _____ HOLE DIA. _____ ANGLES _____ FINISH _____ DATE 10/12/88 FAMILY OF PARTS ENG 1	MATERIAL _____ FINISH _____ SHEET 1 OF 1 DRAWING NUMBER B 145083



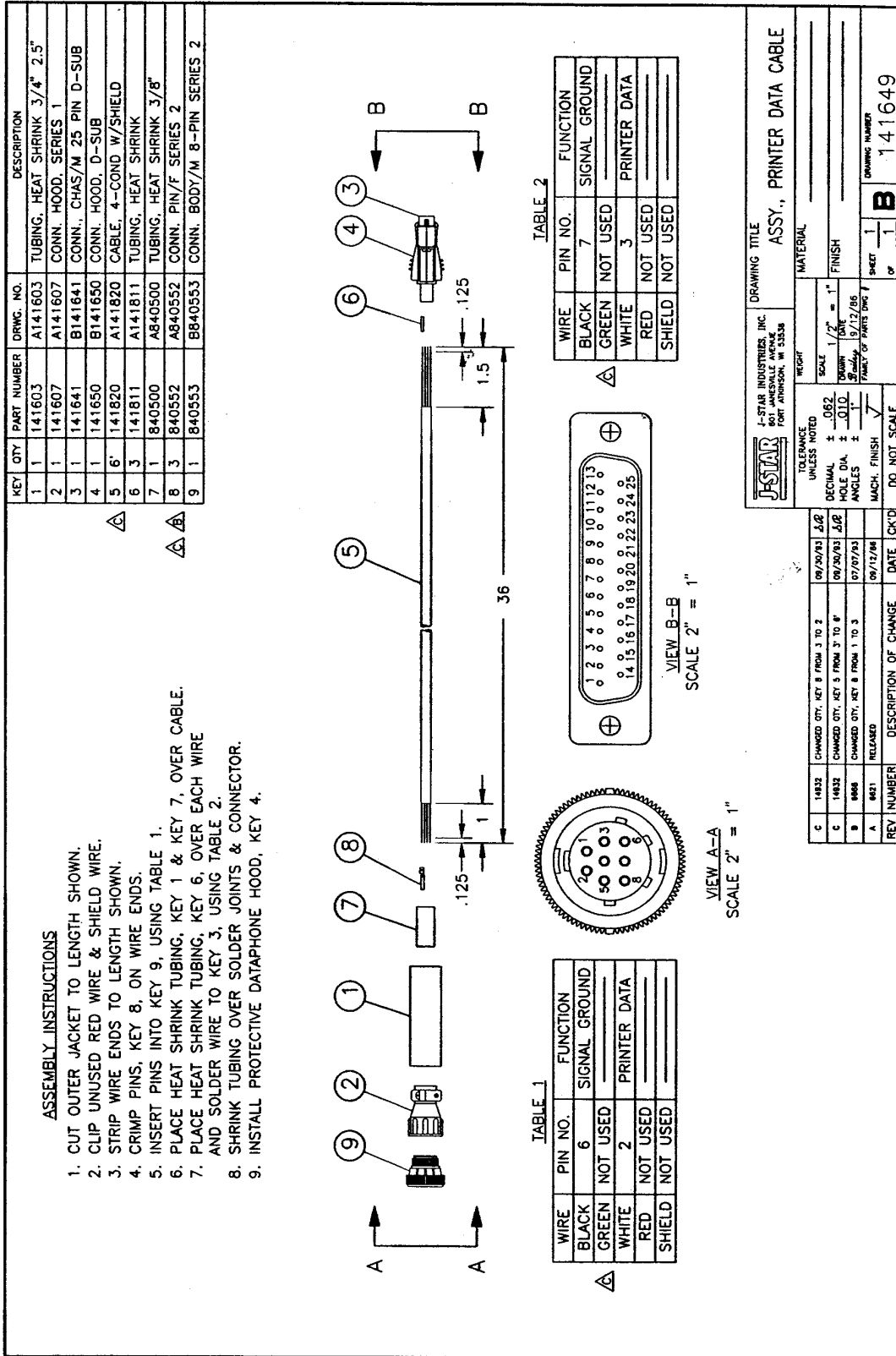

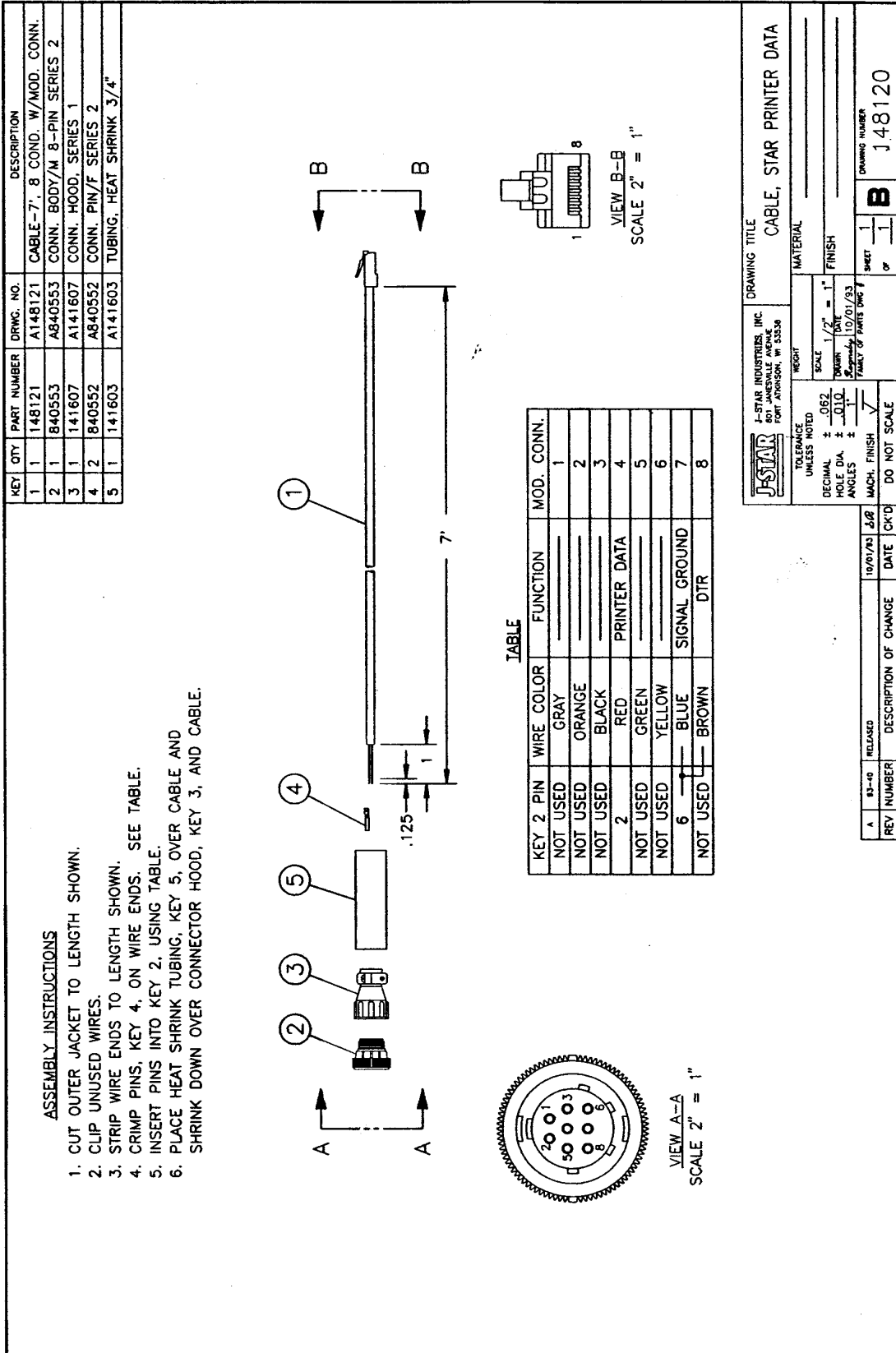
KEY	QTY	PART NUMBER	DRWG. NO.	DESCRIPTION
1	1	141603	A141603	TUBING, HEAT-SHRINK 3/4"
2	1	141607	A141607	CONN. HOOD, SERIES 2
3	AS REQD	141820	A141820	CABLE, 4 WIRE, WITH SHIELD
4	1	840500	A840500	TUBING, HEAT-SHRINK 3/8"
5	2	840552	A840552	CONN. PIN/M. SERIES 2
6	1	840553	B840553	CONN. BODY/F 8 PIN SERIES 2

**ASSEMBLY INSTRUCTIONS**

1. CUT OUTER JACKET TO LENGTHS SHOWN.
2. CLIP UNUSED GREEN & WHITE WIRES & SHIELD WIRE.
3. STRIP WIRE ENDS TO LENGTH SHOWN, CRIMP PINS (KEY 5) ON WIRE ENDS.
4. INSERT PINS INTO KEY 6, USING TABLE 1.
5. PLACE HEAT SHRINK TUBING KEY 1 & KEY 4, OVER CABLE. SHRINK TUBING OVER CONNECTOR HOOD, KEY 2.

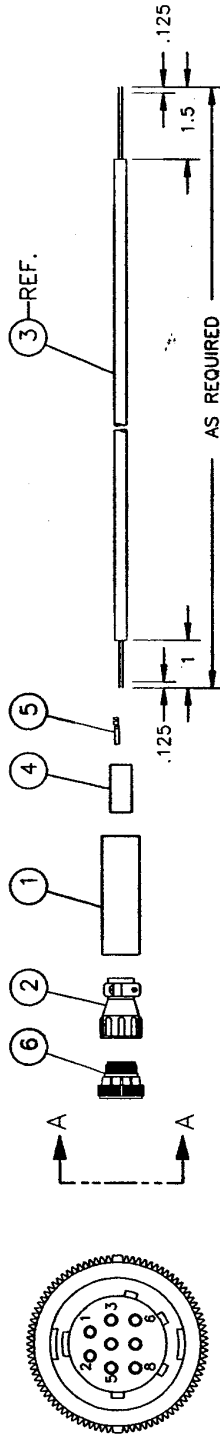

VIEW A-A  
SCALE 2" = 1"

TABLE 1

WIRE	PIN NO.	FUNCTION
RED	1	CURRENT LOOP +
GREEN	NOT USED	
WHITE	NOT USED	
BLACK	8	CURRENT LOOP -
SHIELD	NOT USED	

**JSTAR**  
I-STAR INDUSTRIES, INC.  
801 WASHINGTON AVENUE  
FORT ATKINSON, WI 53538

**DRAWING TITLE**  
CABLE, EZ SERIES, 20ma DATA

**MATERIAL**  
FINISH

**TOLERANCE UNLESS NOTED**  
DECIMAL ± .062  
ANGLE DIA. ± .010  
ANGLES ±

**WEIGHT**  
SCALE 1/8" = 1"  
THICKNESS 1/32"  
DATE 10/13/92  
FAMILY OF PARTS ENG 7

**REVISIONS**

REV	NO	RELEASED	DATE	BY	DESCRIPTION OF CHANGE
A	1		10/13/92	JCB	

**DRAWING NUMBER**  
SHEET 1 OF 1  
**B** 146889

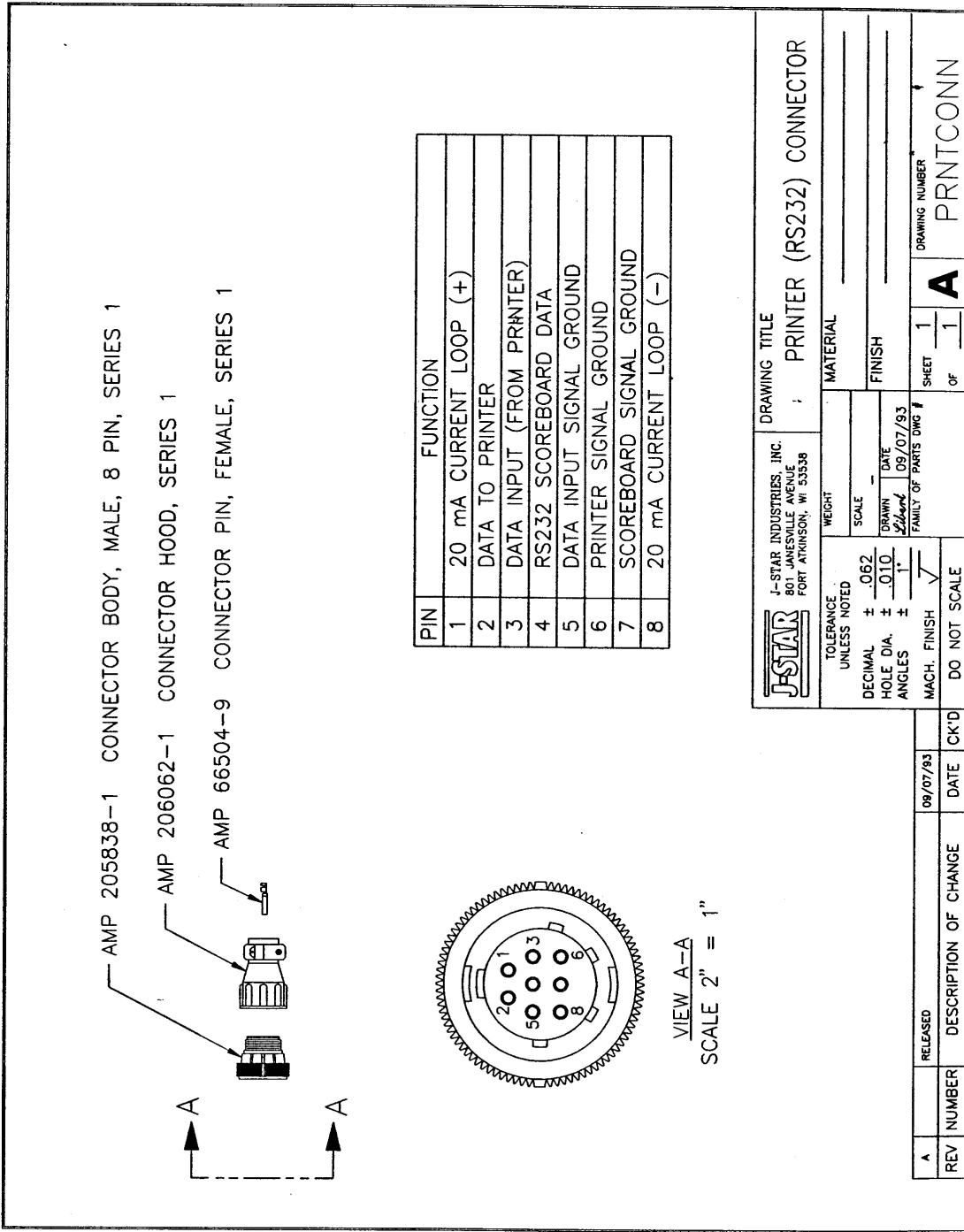

PIN	FUNCTION
1	20 mA CURRENT LOOP (+)
2	DATA TO PRINTER
3	DATA INPUT (FROM PRINTER)
4	RS232 SCOREBOARD DATA
5	DATA INPUT SIGNAL GROUND
6	PRINTER SIGNAL GROUND
7	SCOREBOARD SIGNAL GROUND
8	20 mA CURRENT LOOP (-)

		J-STAR INDUSTRIES, INC. 801 JANESVILLE AVENUE FORT ATKINSON, WI 53538		DRAWING TITLE PRINTER (RS232) CONNECTOR	
TOLERANCE UNLESS NOTED DECIMAL ± .062 HOLE DIA. ± .010 ANGLES ± 1°		WEIGHT SCALE DRAWN: <i>Edward</i> DATE: 09/07/93 FAMILY OF PARTS DWG #		MATERIAL FINISH	
MACH. FINISH <input checked="" type="checkbox"/> DO NOT SCALE		SHEET 1 OF 1		DRAWING NUMBER PRNTCONN	

REV	NUMBER	RELEASED	DESCRIPTION OF CHANGE	DATE	CK'D
A				09/07/93	

VIEW A-A  
SCALE 2" = 1"

- ACCUM (3200 Only), 33
- Adjusting Indicator
  - Matching another scale, 53
- AL OUT, 29
- Appendix A Short Form Calibration, 52
- BUZZER (Buzzer Setup), 30
- Computer Command Set
  - Numeric Entry Commands, 42
  - Single Letter Commands, 42
- Computer Interface Print Samples, 46
- Connecting to Other Load Cells, 54
- DDL Set Up Requirements, 50
- DELAY (3200 Only), 32
- DRATIO, 31
- E MTHD (3200 Only), 31
- Full Scale Calibration
  - ADD WT, 37
- Help, 10
- INGTBL (3200 Only), 32
- Initiating a Key Test, 68
- Keypad Failure Error Codes, 67
- Long Form Calibration Menu
  - TCALB (Temperature Calibration), 36
  - ZERO, 36
- Long Form Menu 1 Options
  - D RATE (Display Rate), 11
  - LANGAG (Language), 10
  - MOTION (Motion Setup), 12
  - TR HLD (TR Inventory Hold), 14
- Long Form Menu 1 Options Menu
  - W MTHD (Weigh Method Setup), 13
  - Z TRACK (Zero Track Setup), 12
- Long Form Menu 2 Options
  - 1L PRT (One Line Printing), 18
  - APRINT (Auto Print), 19
  - BUZZER, 21
  - COM IN (Computer Input Line), 19
  - DATE, 17
  - DATE F (Date Format), 16
  - EST WT (Estimated Gross Weight), 21
  - PRT DLY (Print Delay), 21
  - SCOREM (Scoreboard Mode), 18
  - TAREAP (Tare Auto Print), 17
  - TIME, 15
  - TIME F (Time Format), 15
- Long Form Menu 3 Options
  - ARANGE (Auto Range), 22
  - CAP (Scale Capacity Setup), 23
  - COUNT (Display Count), 22
  - LB-KG (Weight Unit Setup), 22
- Long Form Setup
  - Entering, 8
  - Exiting, 9
  - Menu 1 Options, 10
- Long Form Setup Values, 8
- MIXTMR (3200 Only), 31
- One Line Printing, 18
- P-ALM (3200 Only), 28
- PRETAR (3200 Only), 30
- Print Data Format (One Line), 44
- Print Data Format (Two Line), 42
- Print Samples, 45
- RM INP, 29
- RS-232 Specifications
  - Computer Command Set, 42
- Scoreboard Data Format, 42
- Self Test, 38
  - Pausing the Test, 39
  - Terminating the Test, 39
  - Test Sequence, 38
- Setting the Date, 17
- Setting the Date Format, 16
- Setting the Time, 15
- Setting the Time Format, 15
- Setup and Calibration Numbers
  - Changing, 55
- Short Form Setup
  - Calibration, 7
- Short Form Setup Number
  - Capacity, 6
  - Display Count Index, 6
  - Gain, 5
  - Weigh Method, 5
- Short Form Setup Values
  - Setup Number, 5
- Terminating a Key Test, 68
- Test Sequence
  - Display Program ID, 38
  - Display Setup Values, 38
  - Display Test, 38
  - Starting, 38
  - System Test, 38

TOLER (3200 Only), 32

Weigh Method Adjustment, 27

Weigh Mode, Returning To, 56

Weighing Errors

Capacity Limit, 40

Over Range, 40

Under Range, 40